

Schema 1 (Home Page)

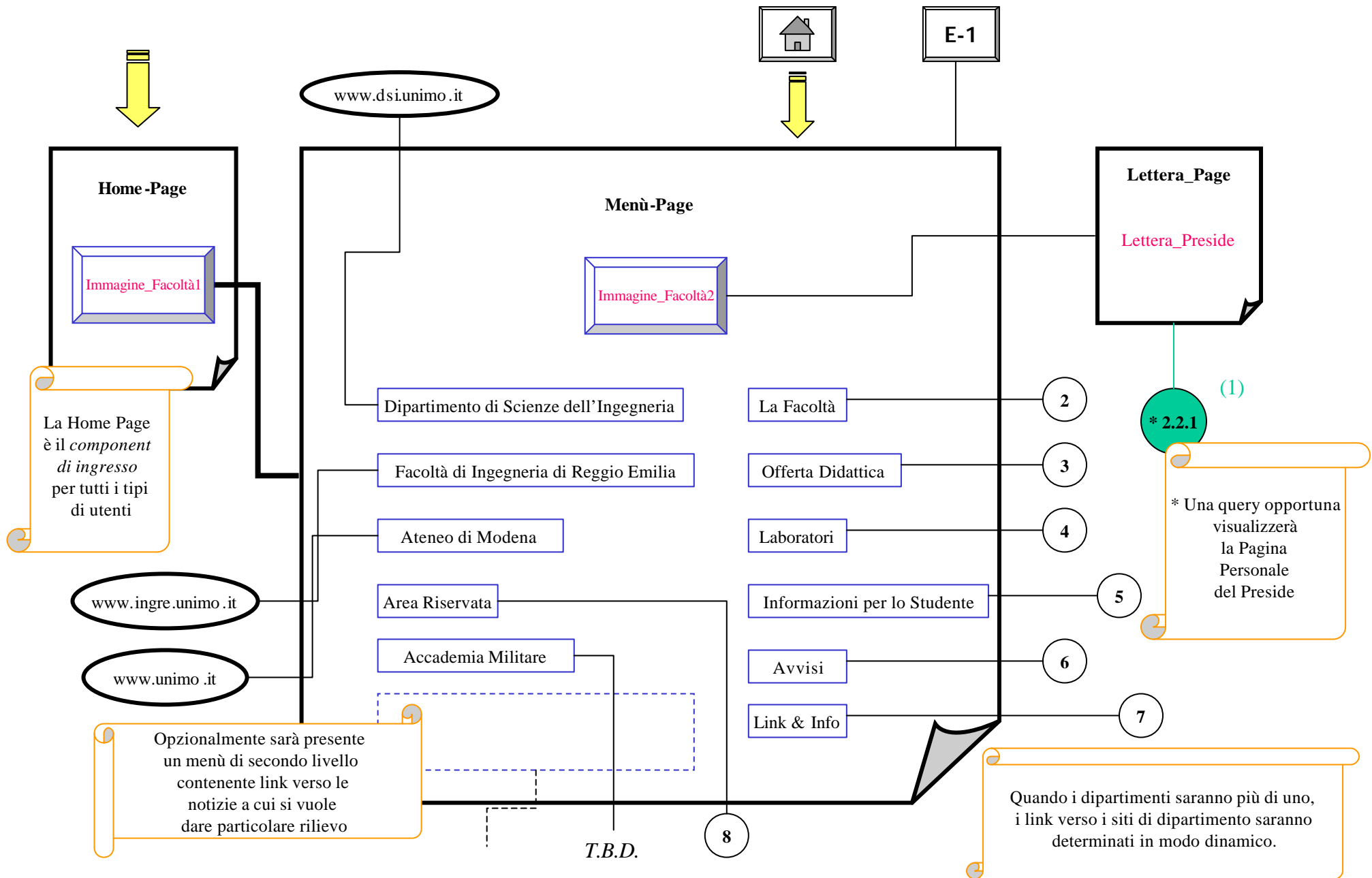

Schema E-1 (Home-Page inglese)

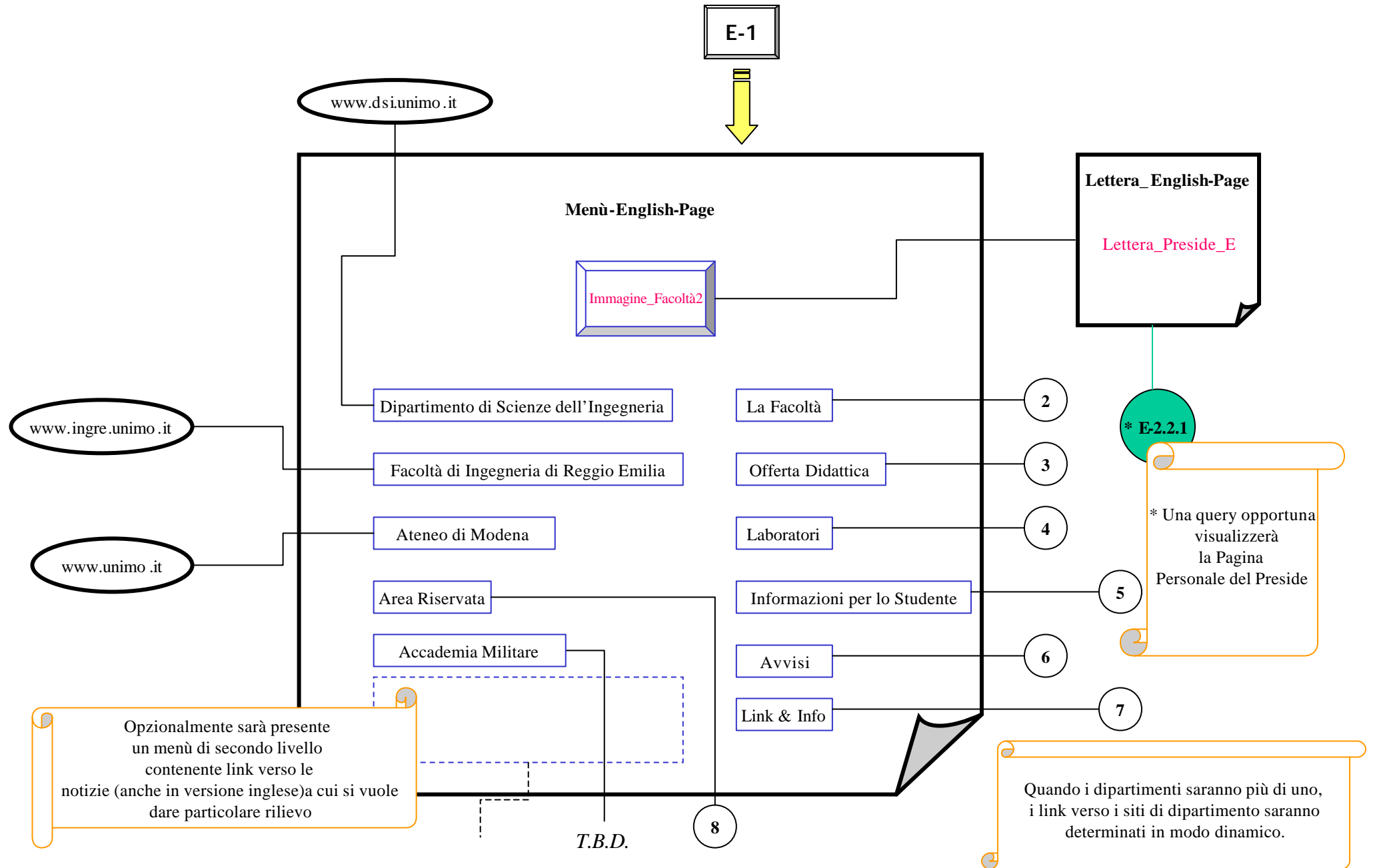

Schema 2 (La Facoltà)

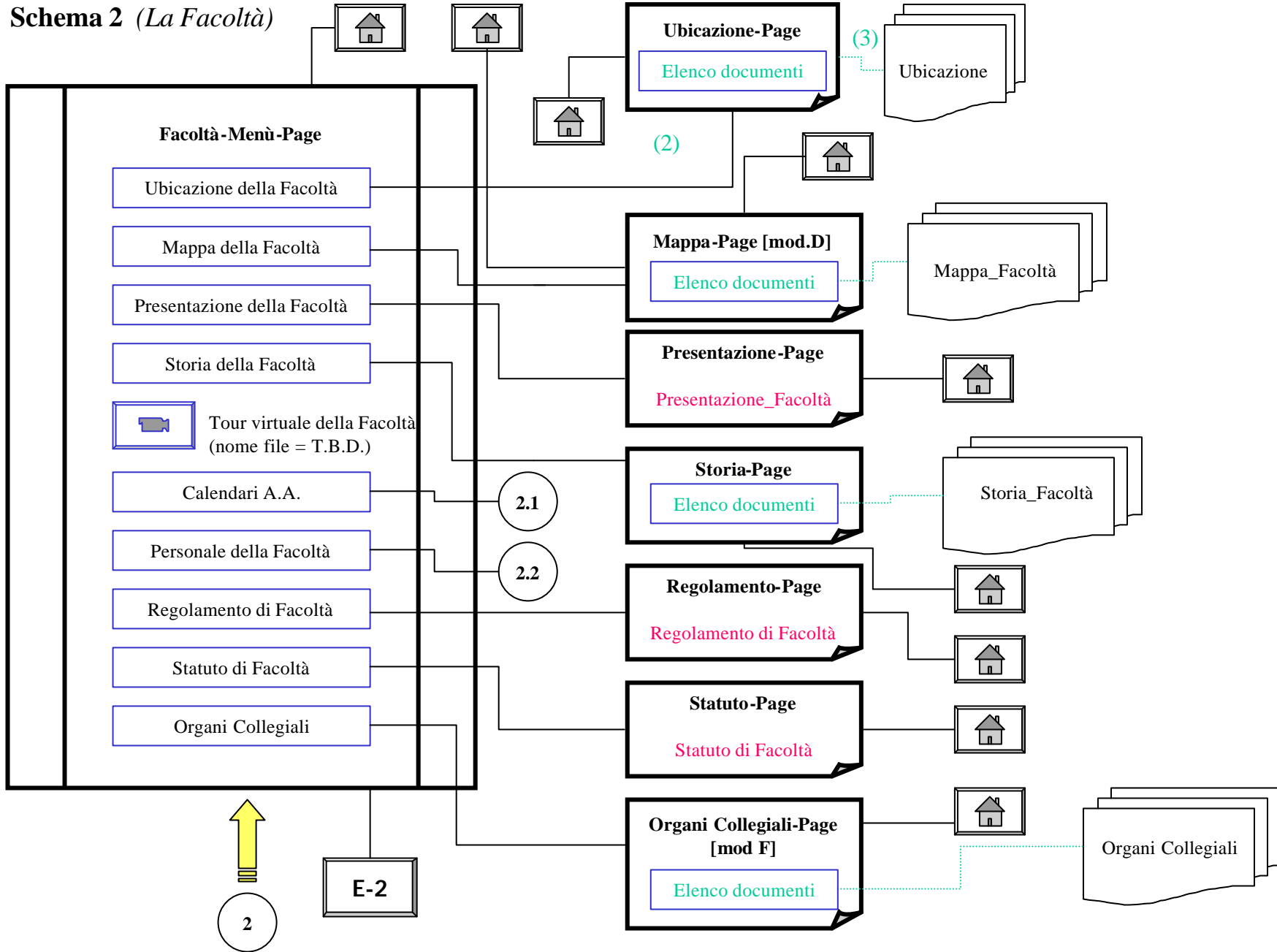

Schema E-2 (La Facoltà-inglese)

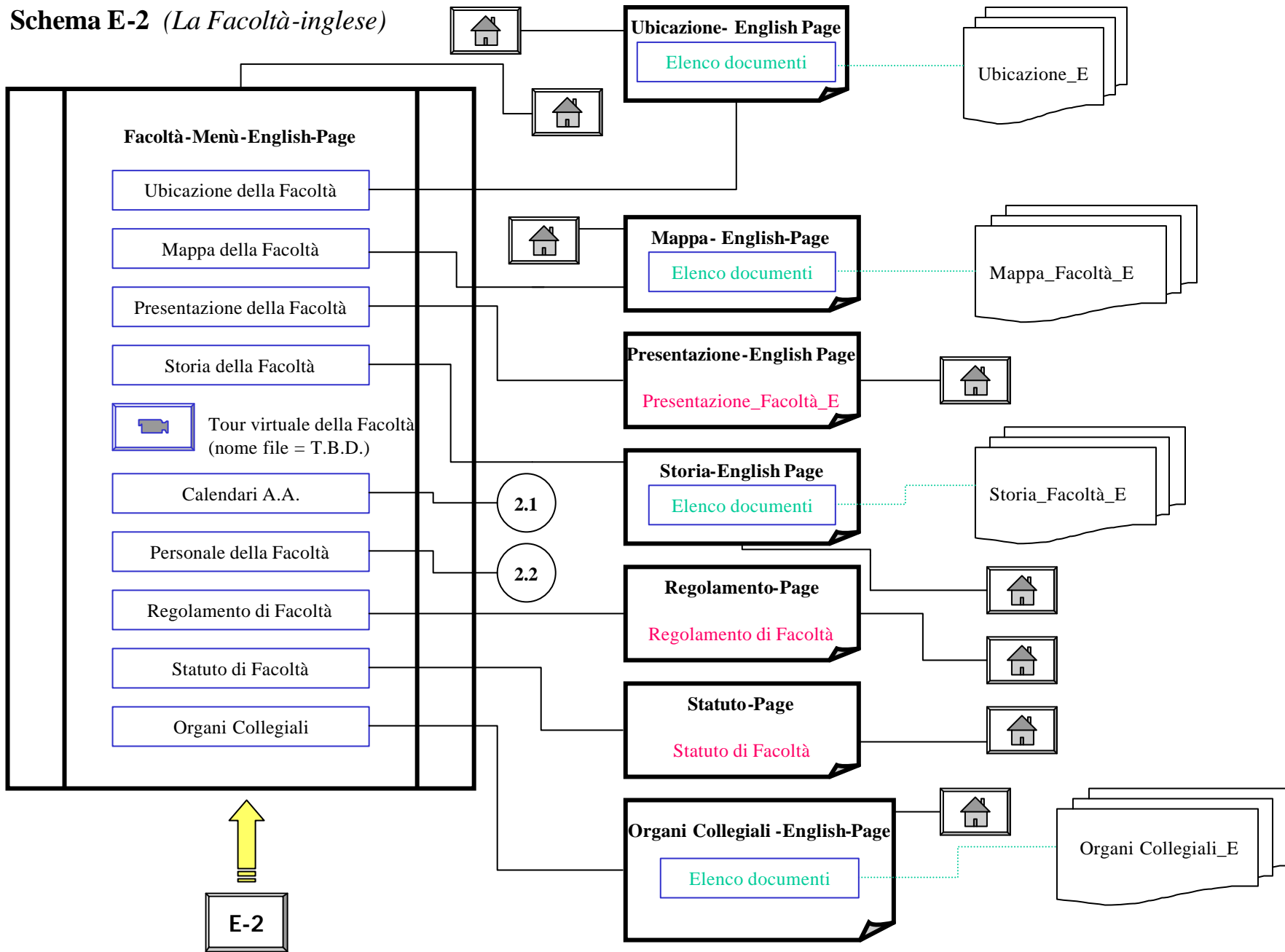

Schema 2.1 (*Calendari*)

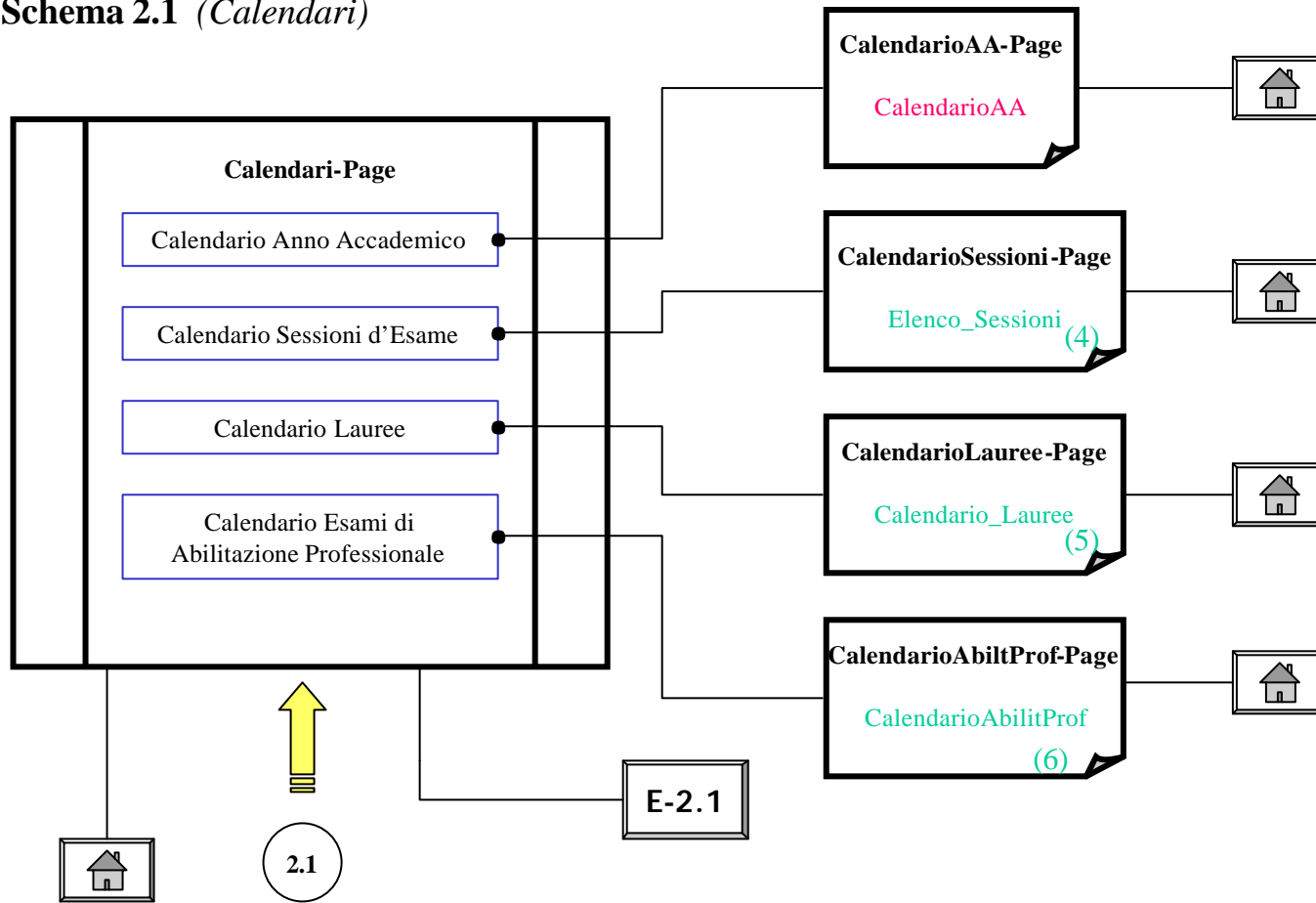

Schema E-2.1 (Calendari-inglese)

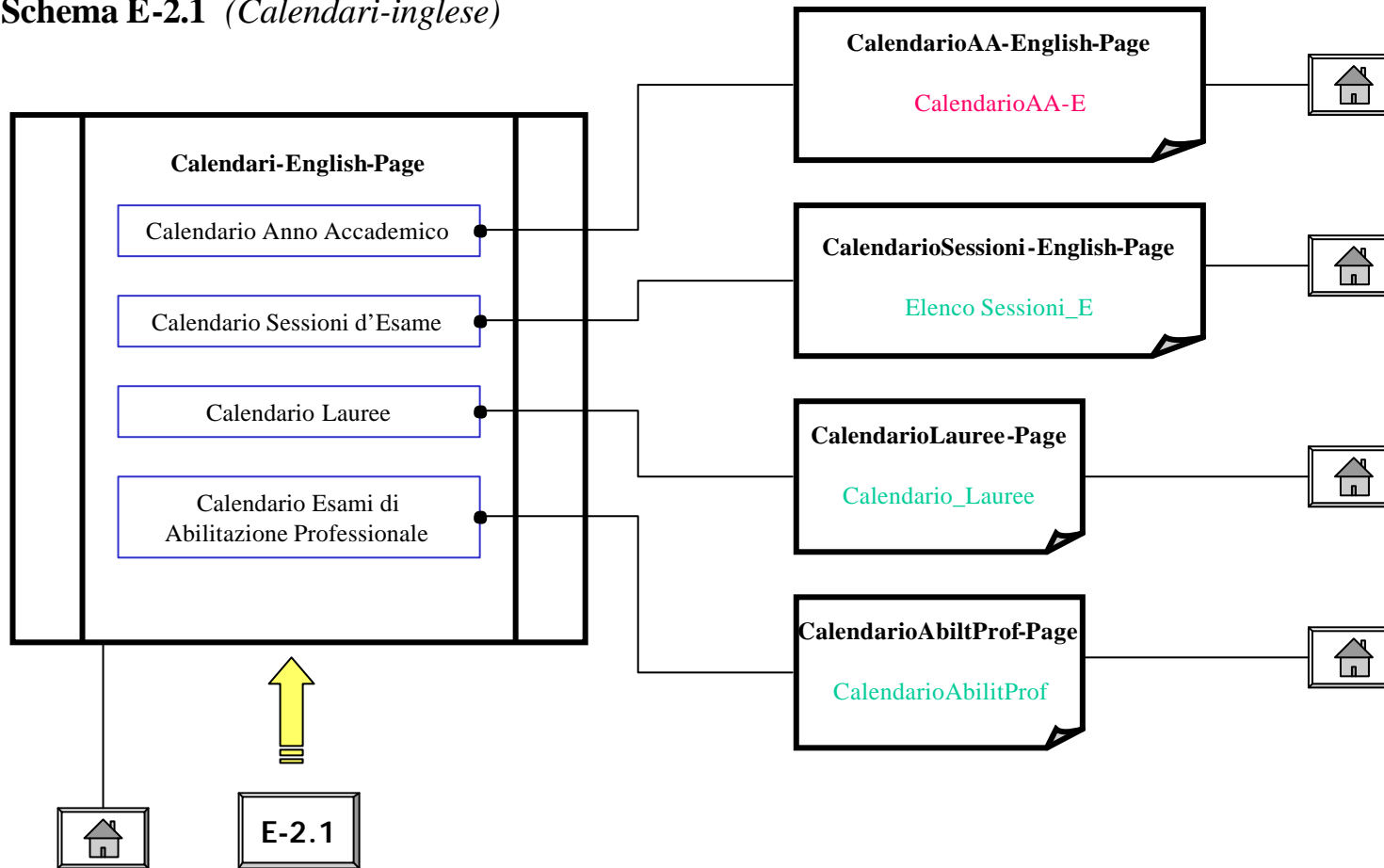

Schema 2.2 (Ricerche sul Personale)

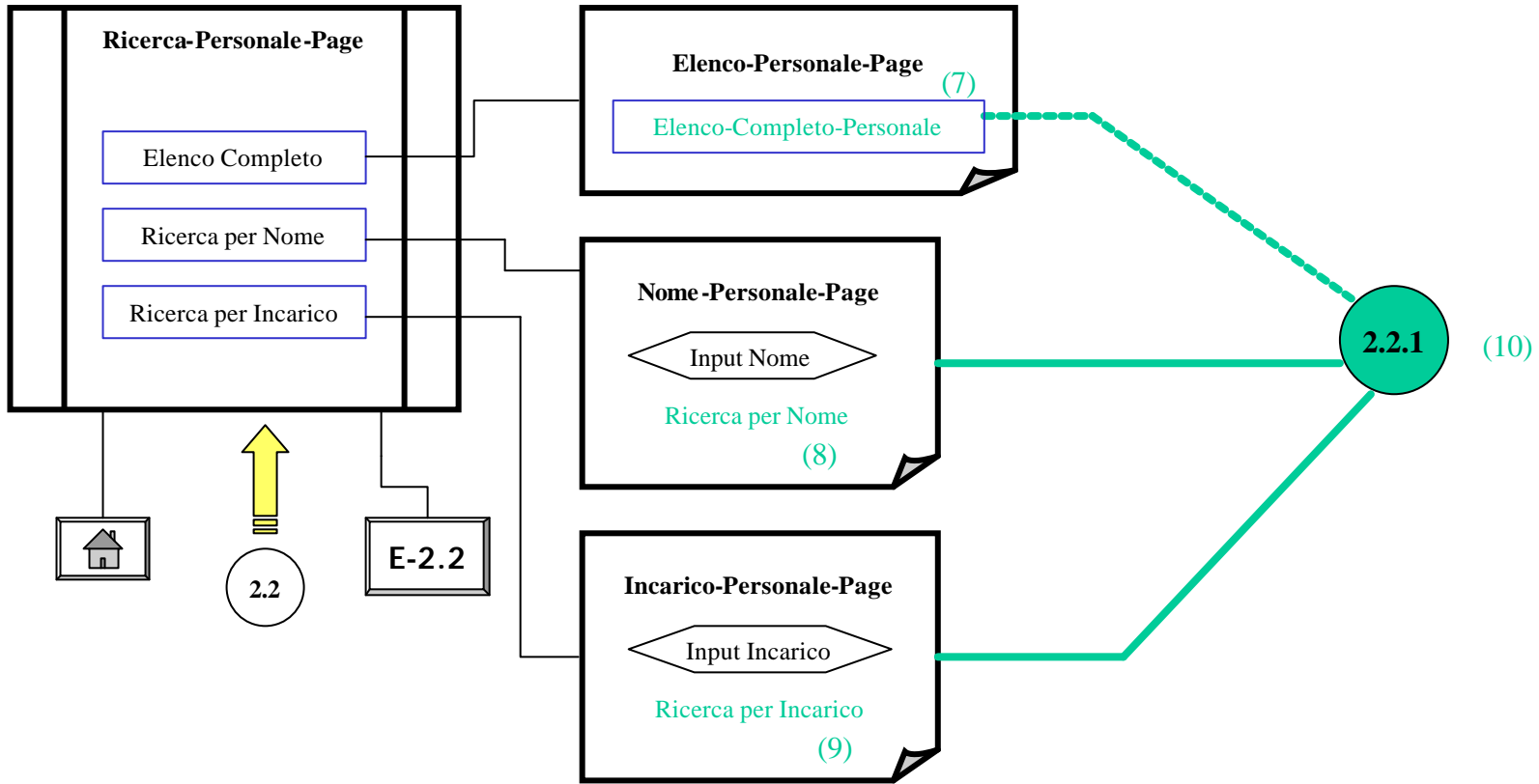

Schema E-2.2 (Ricerche sul Personale-inglese)

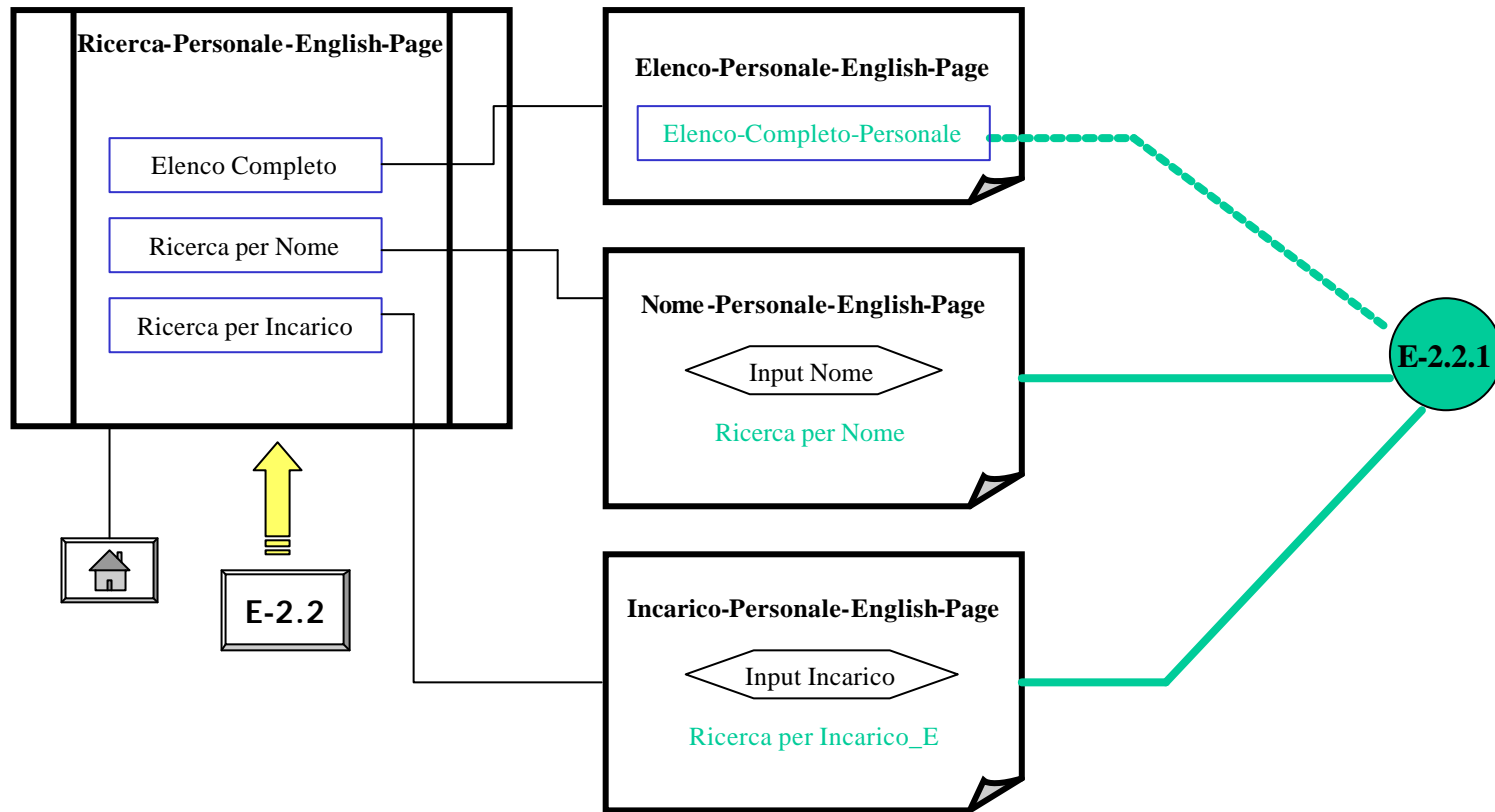

Schema 2.2.1 (Pagina del Personale)

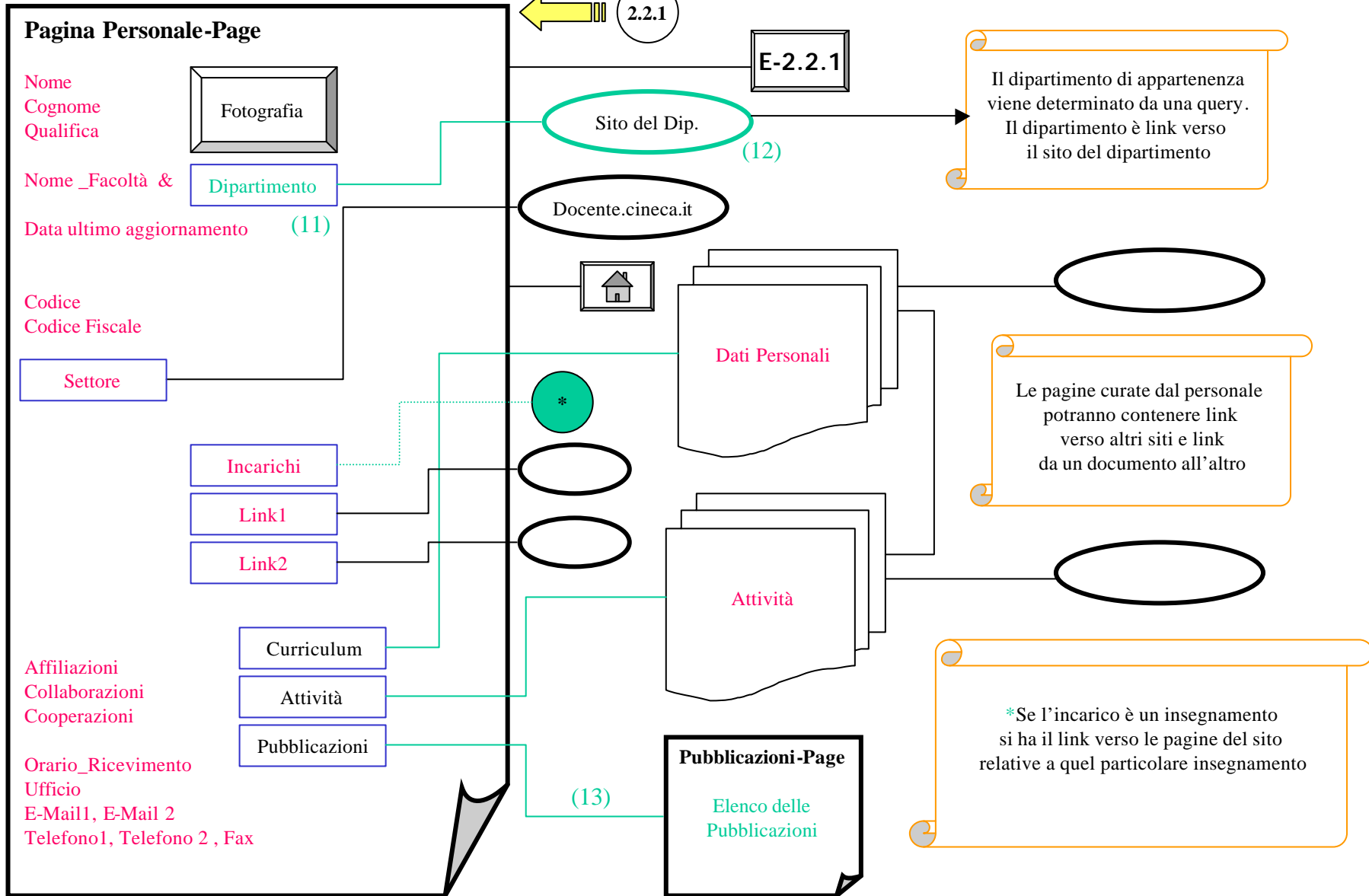

Schema E-2.2.1 (Pagina del Personale-Inglese)

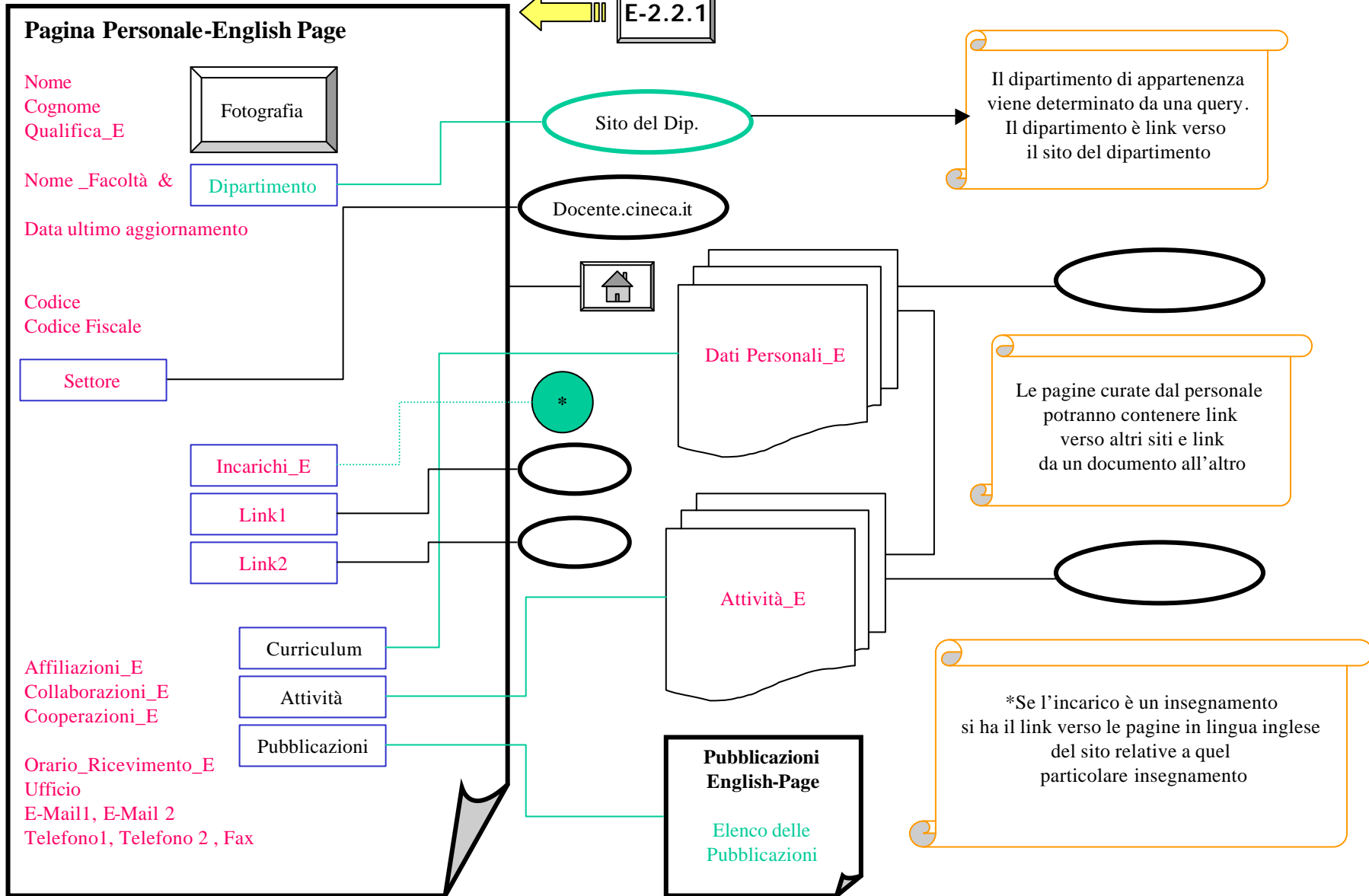

Schema 3 (Offerta didattica)

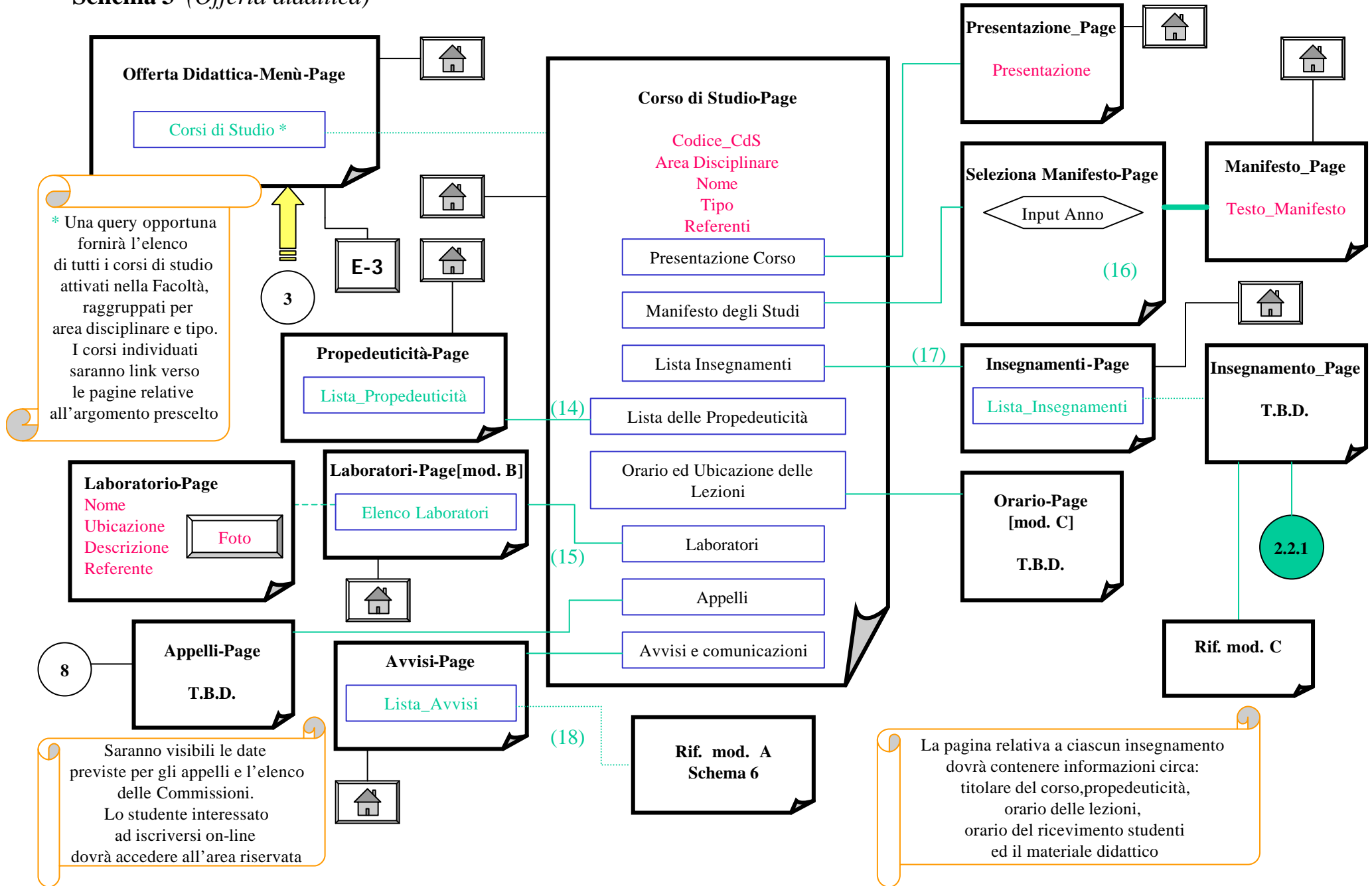

Schema E-3 (Offerta didattica-inglese)

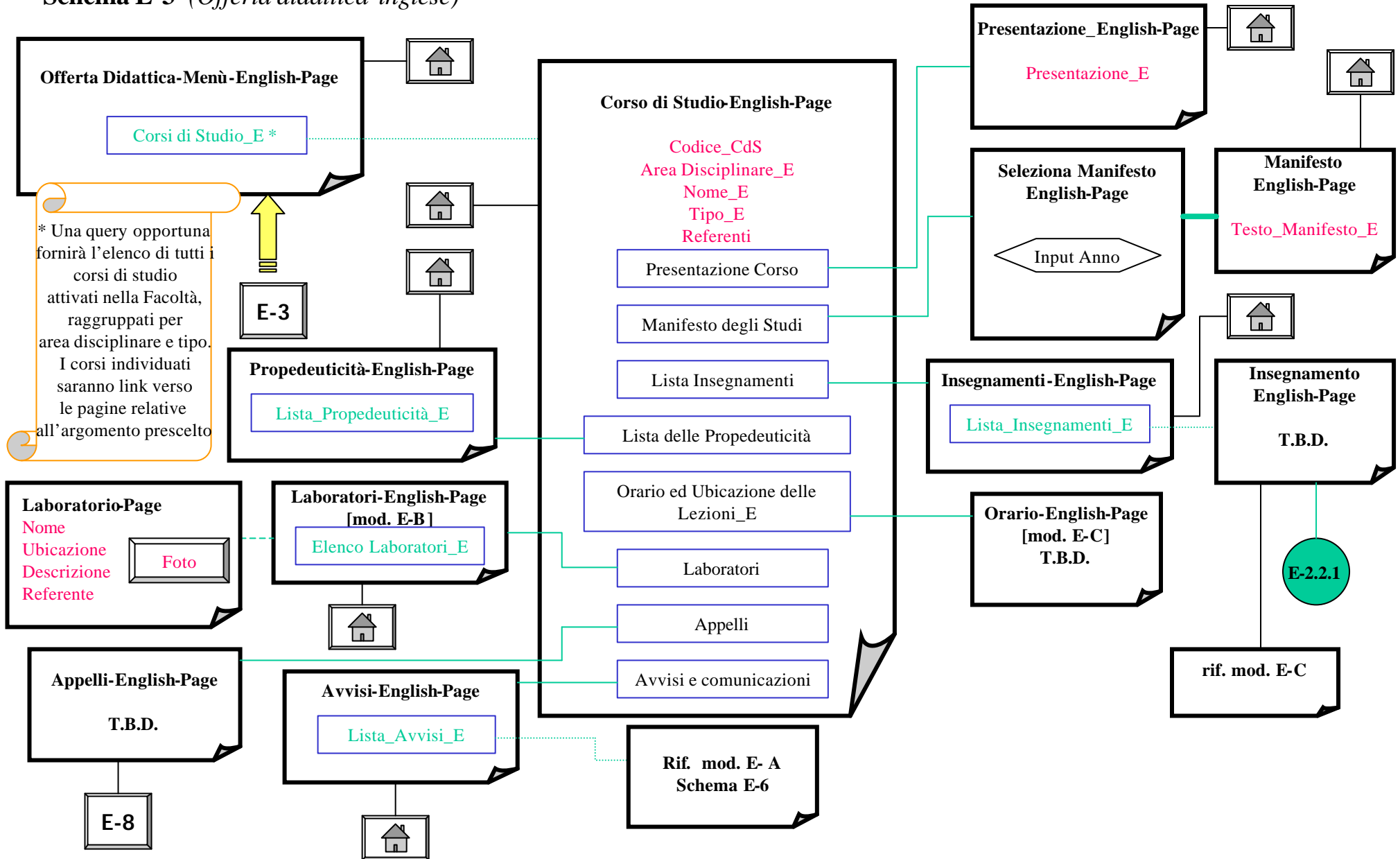

Schema 4 (Laboratori)

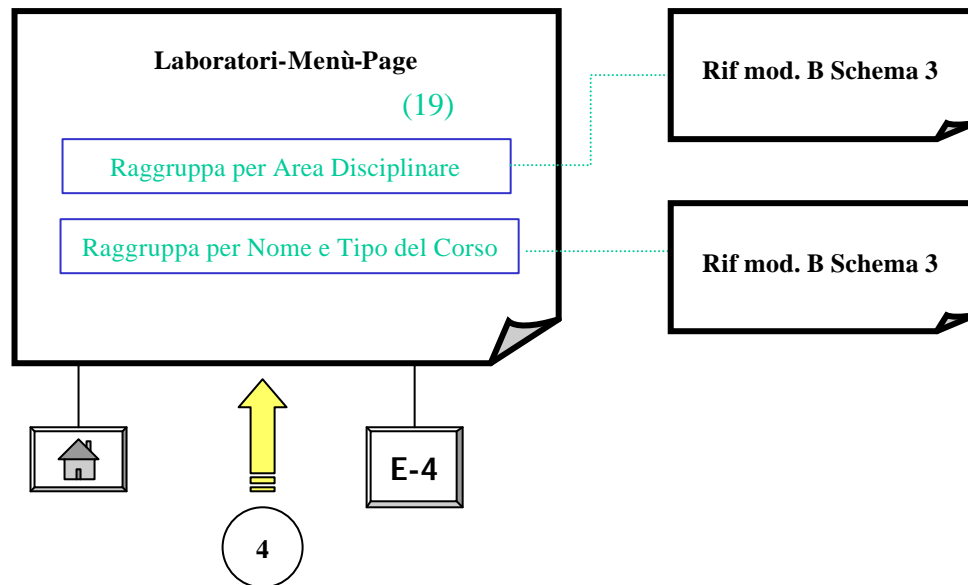

Schema E-4 (Laboratori-inglese)

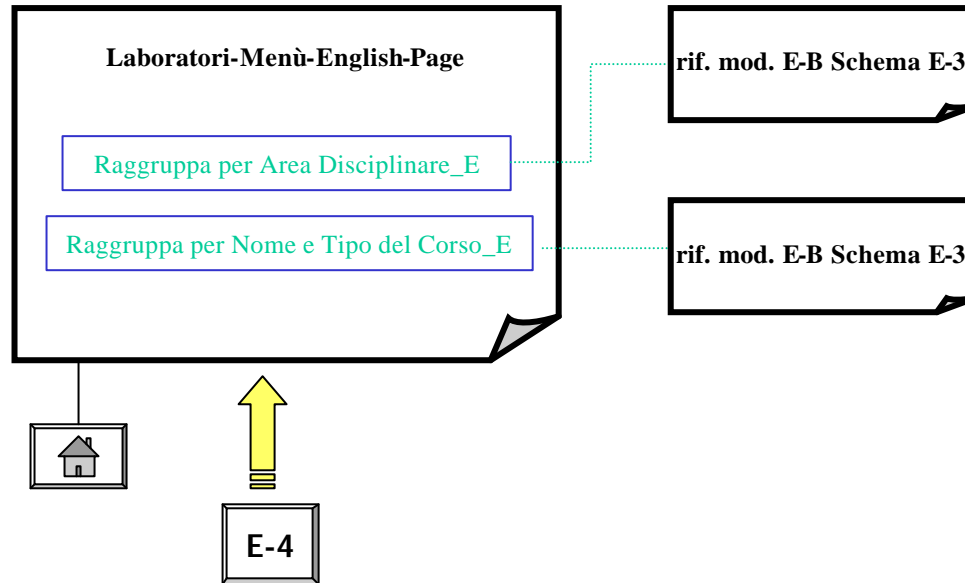

Schema 5 (Studenti)

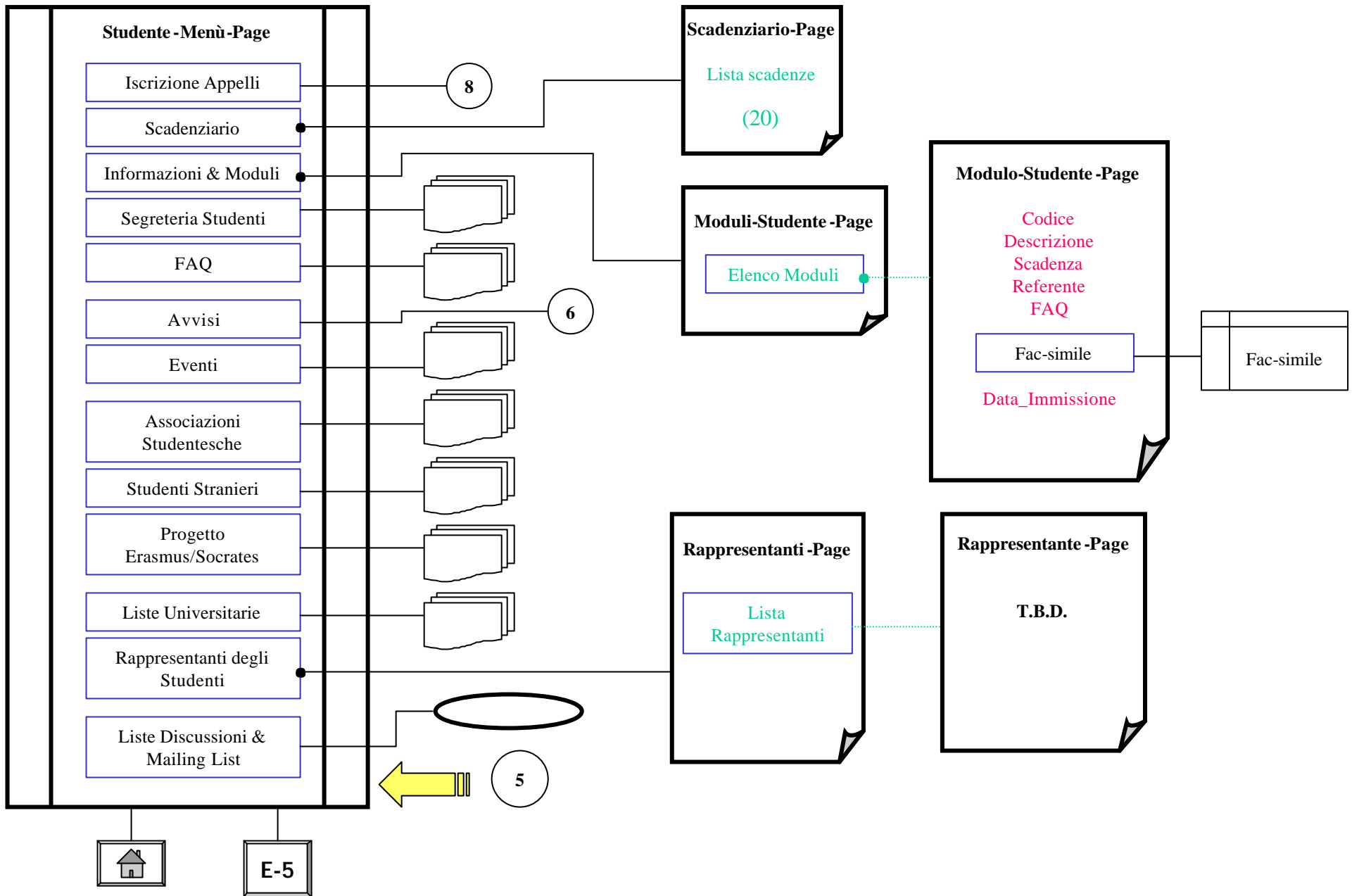

Schema E-5 (Studenti-inglese)

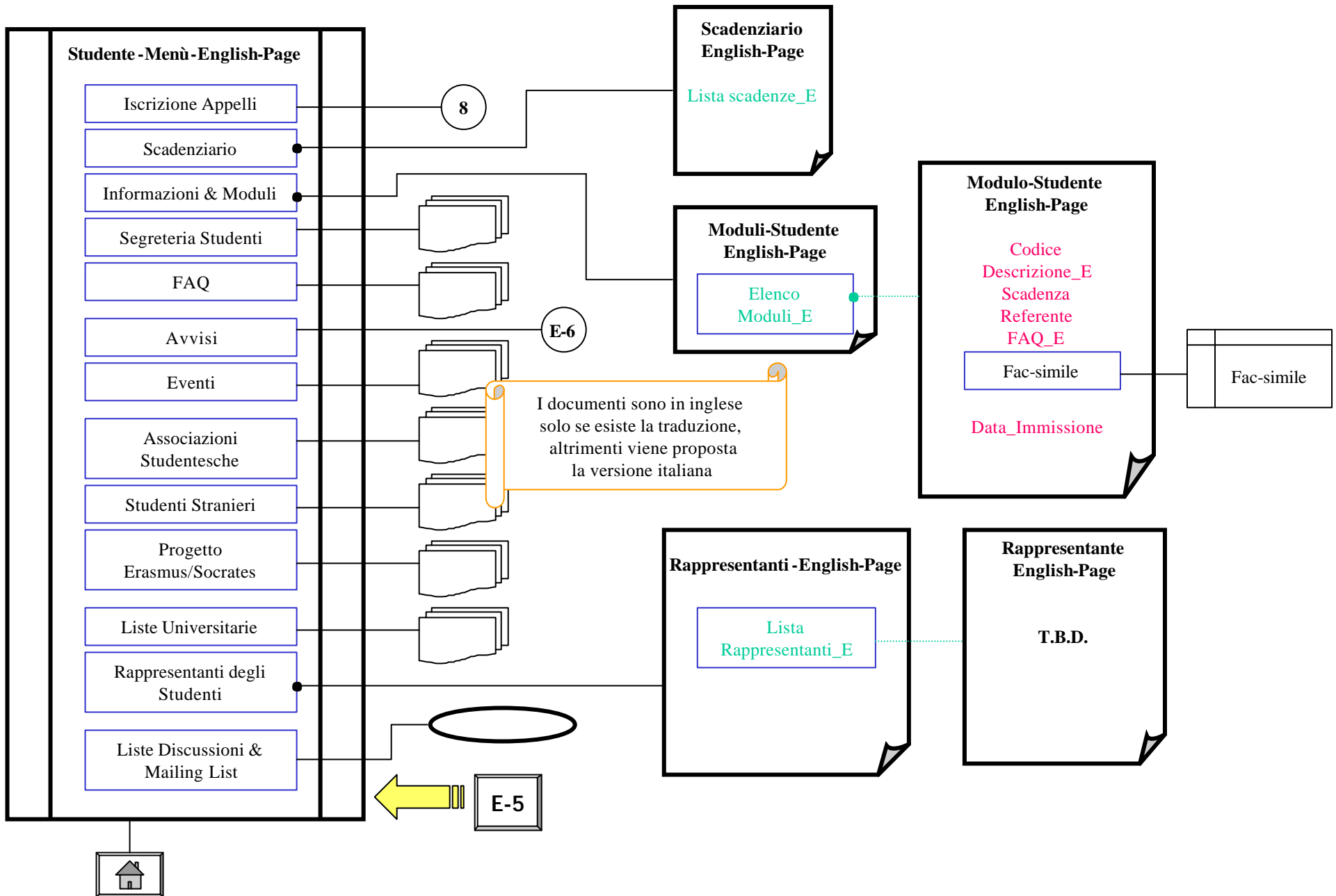

Schema 6 (Avvisi)

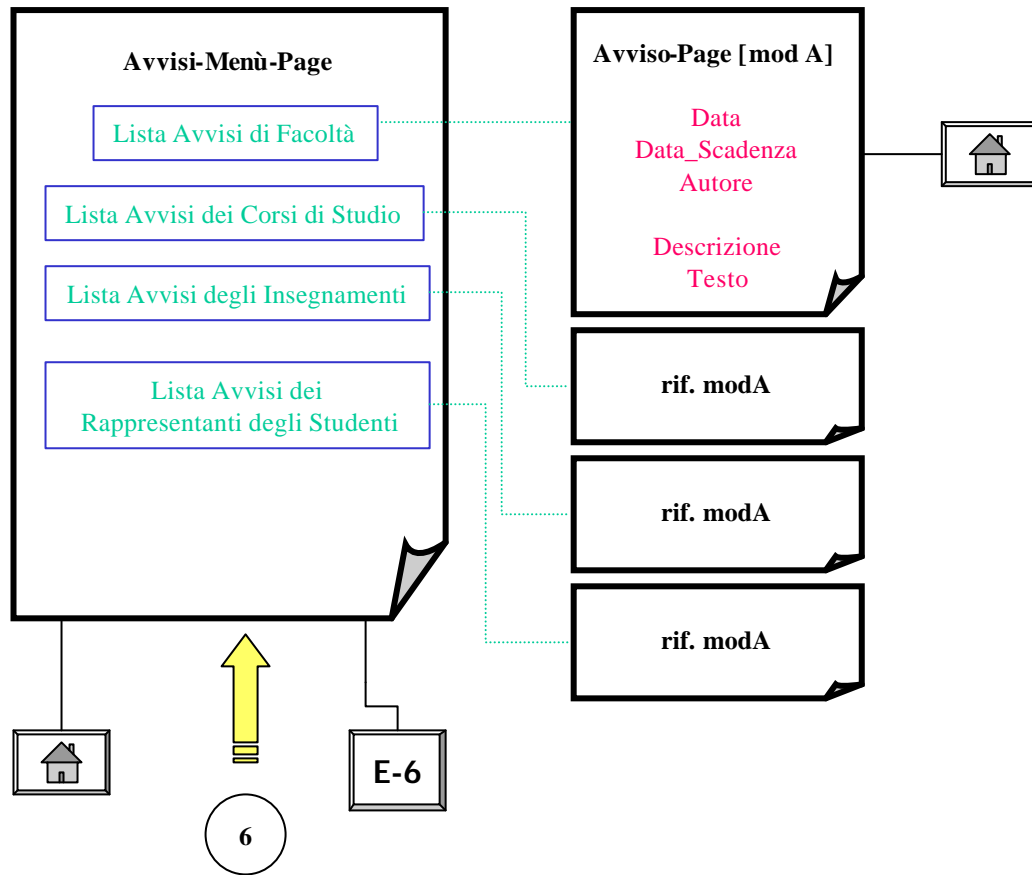

Schema E-6 (Avvisi-inglese)

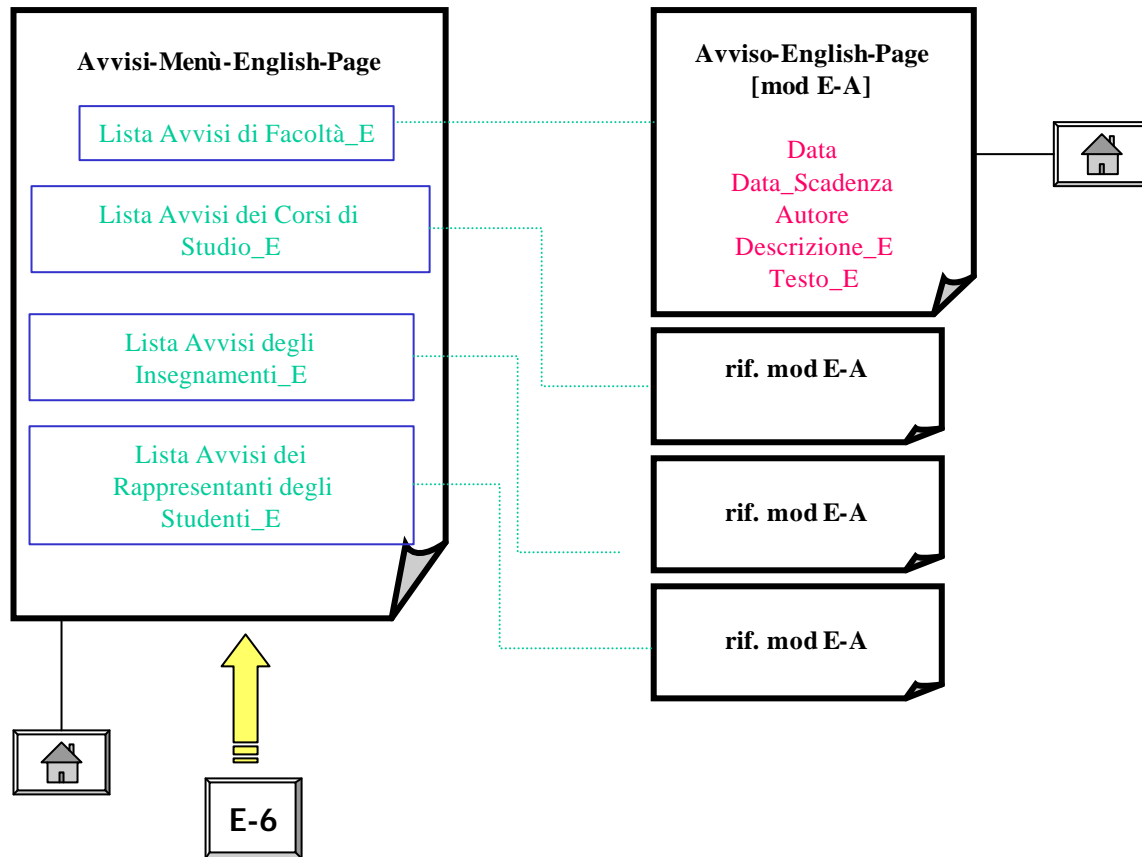

Schema 7 (Informazioni & Link)

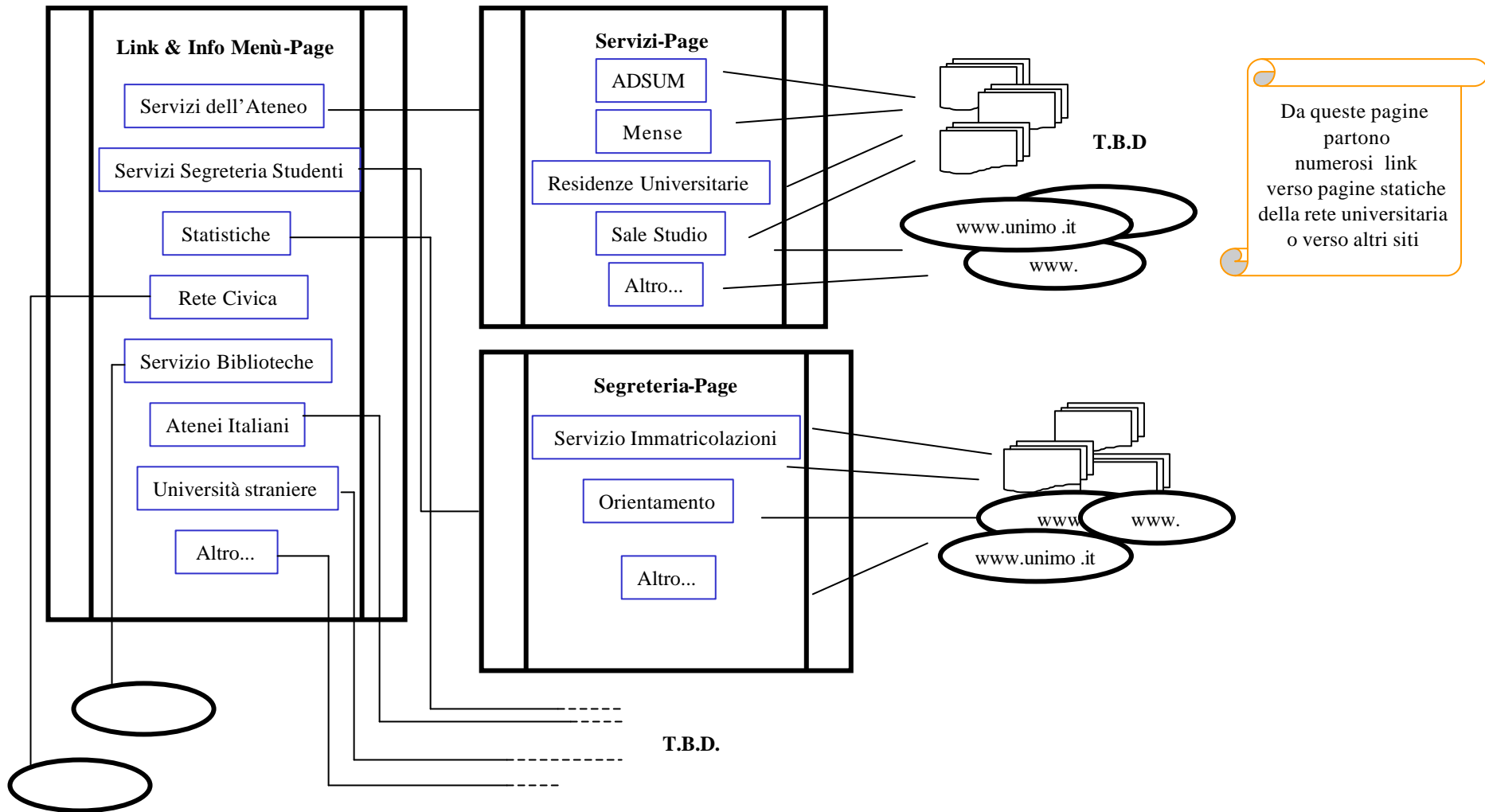

Schema 8 (Area ad accesso protetto)

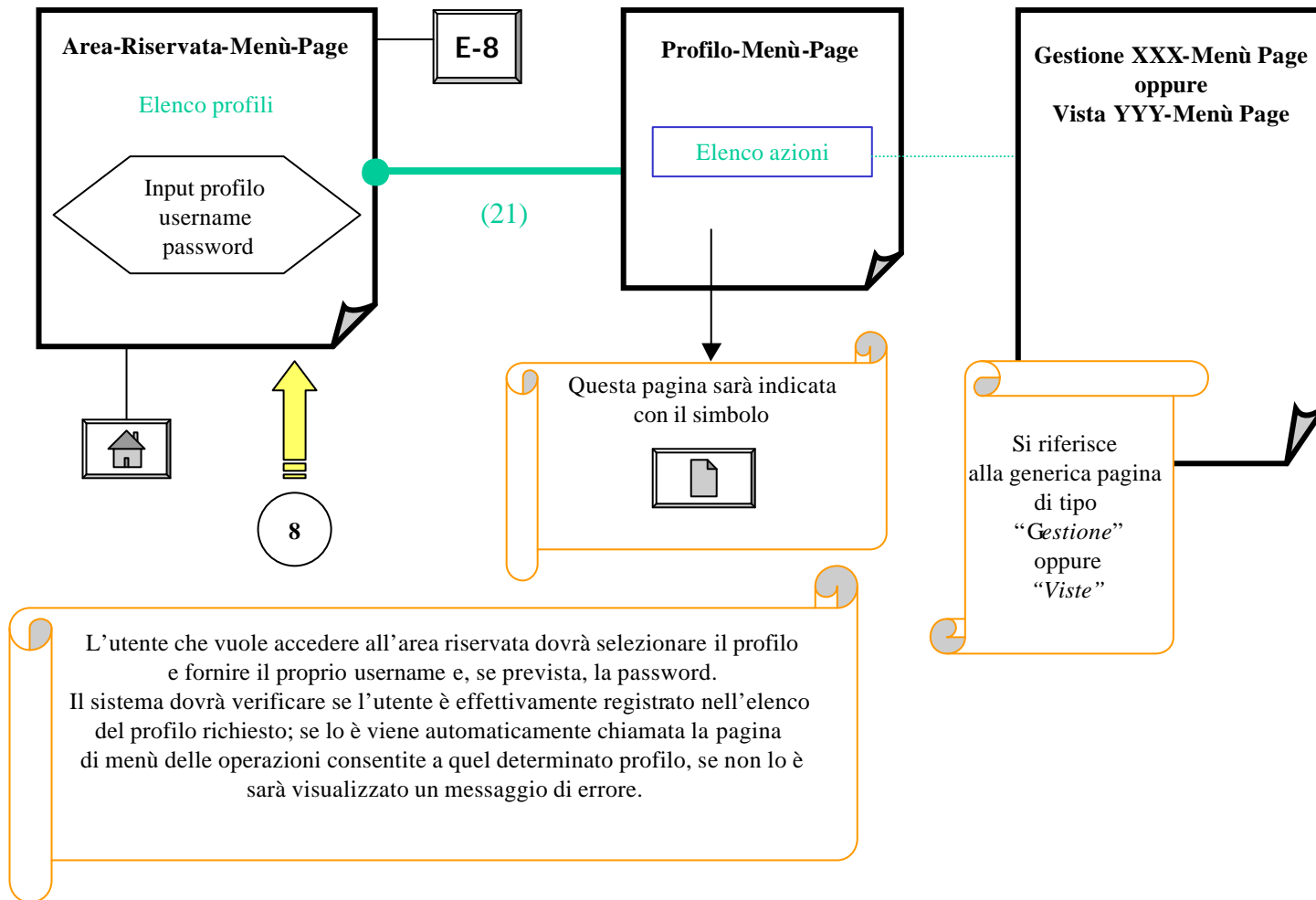

Schema E-8 (Area ad accesso protetto-inglese)

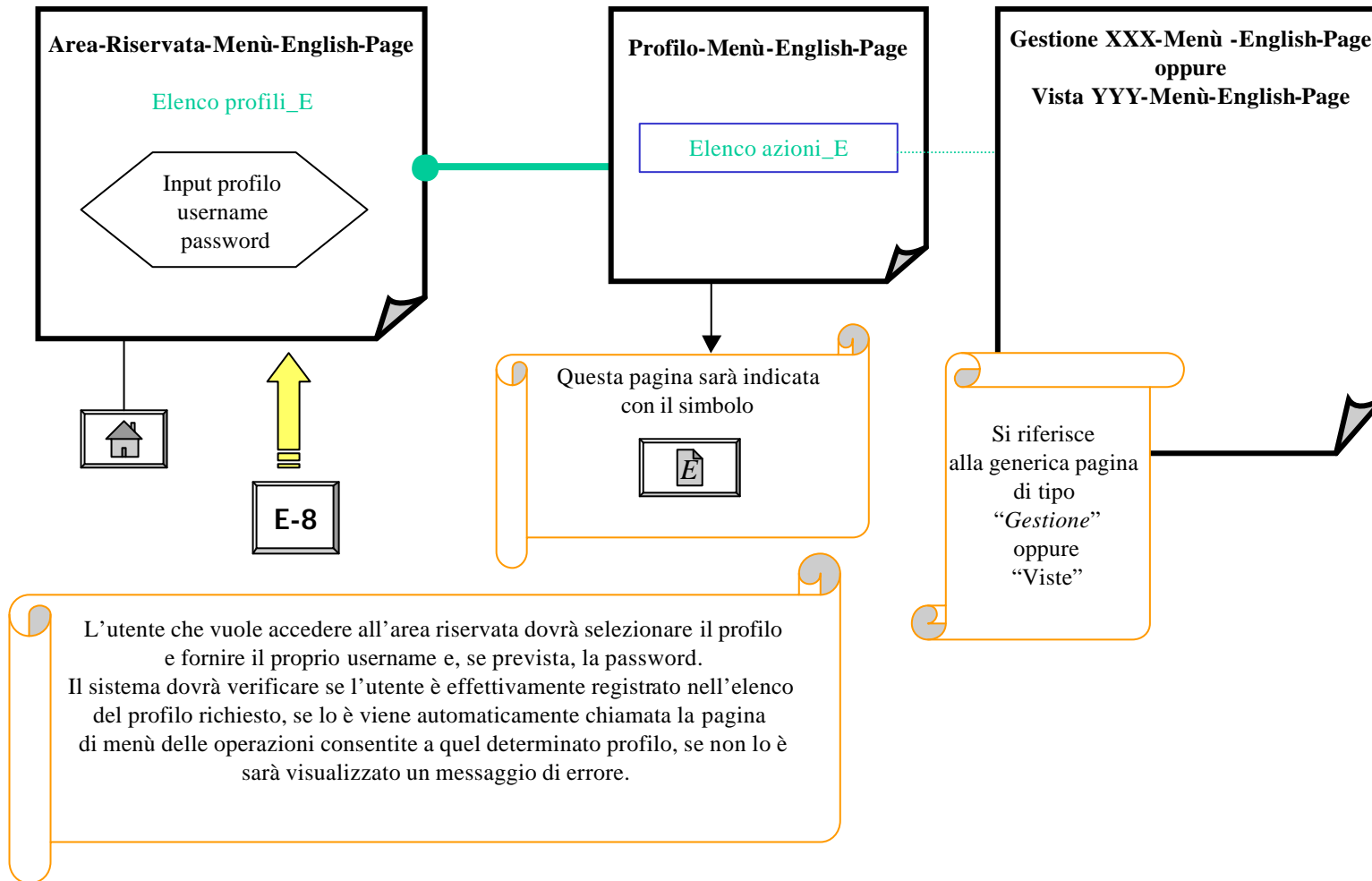

Schema A (Consiglio della Presidenza)

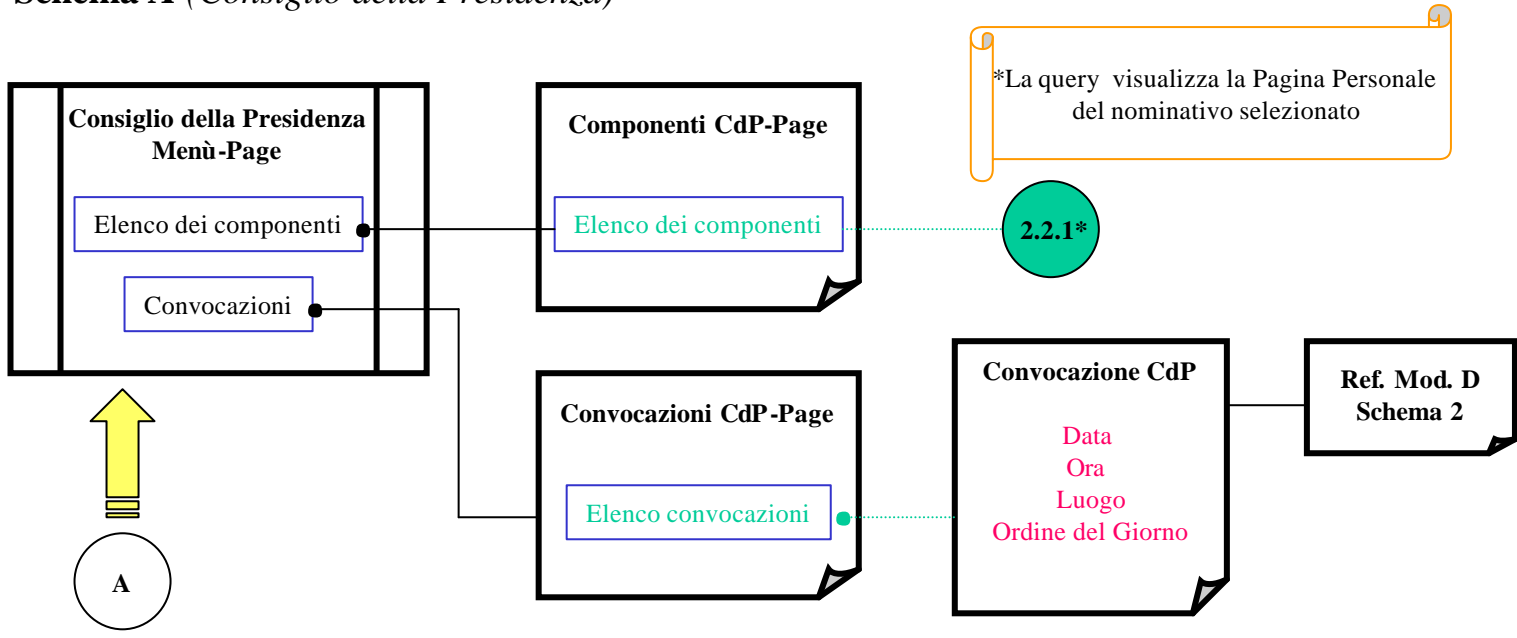

Schema B

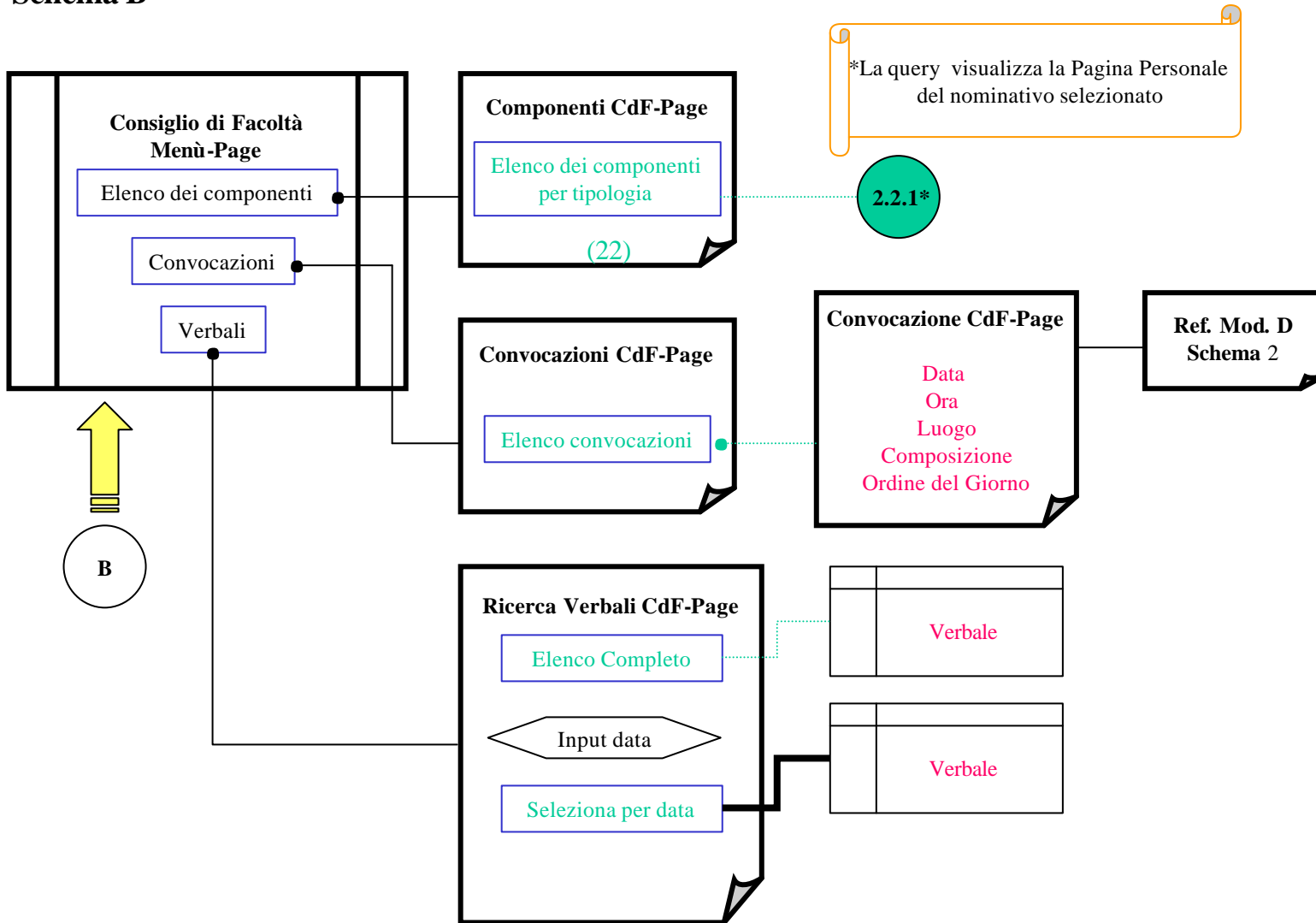

Schema C

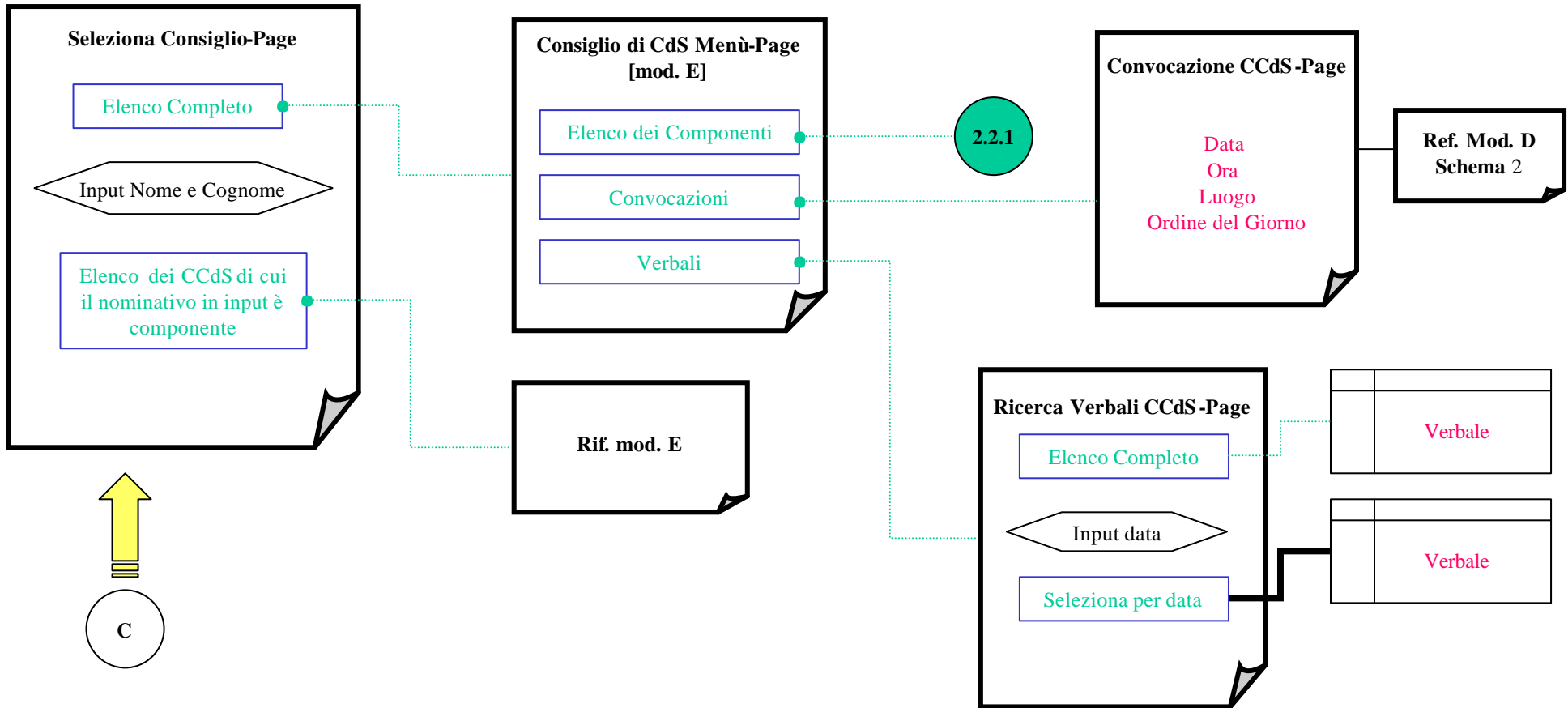

Schema D

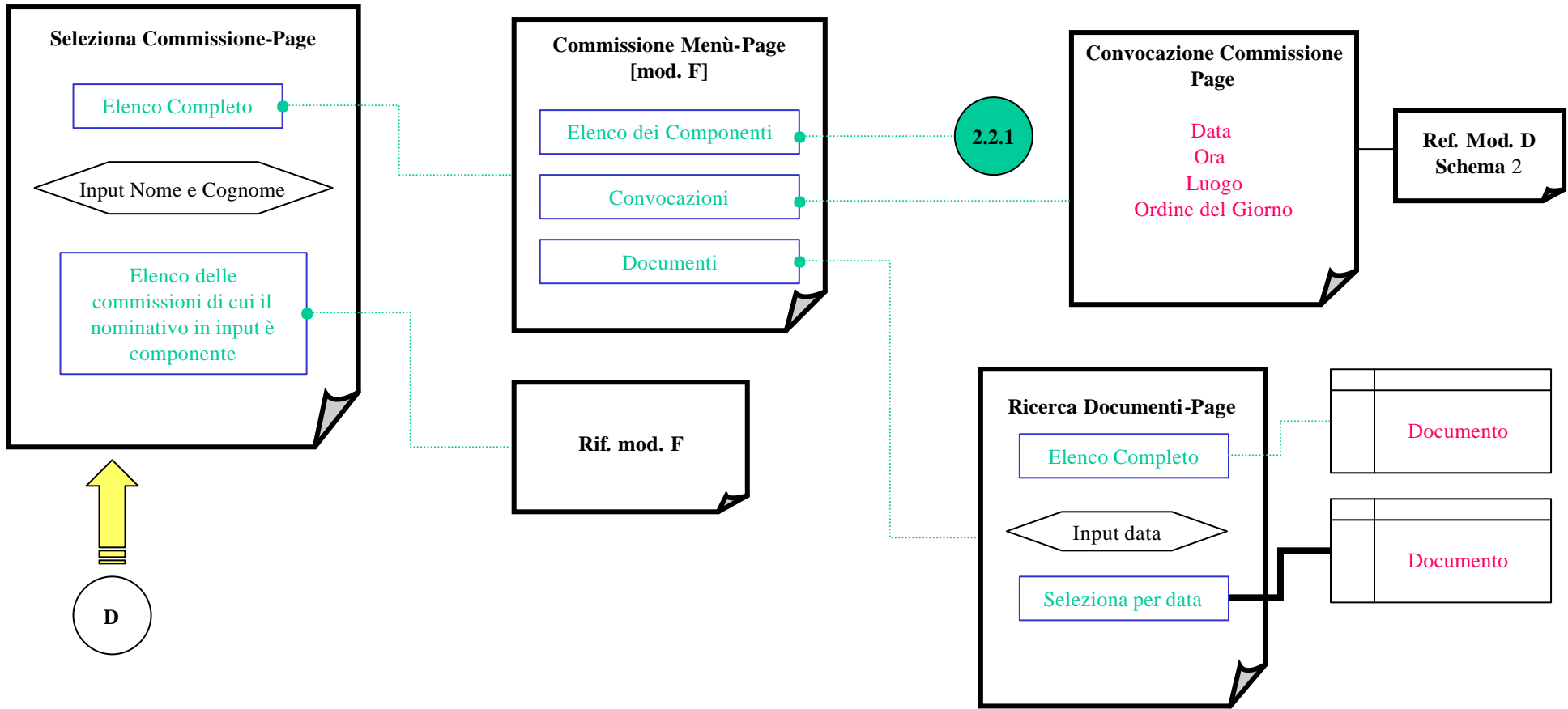

Schema G-1 (Gestione Organi Collegiali)

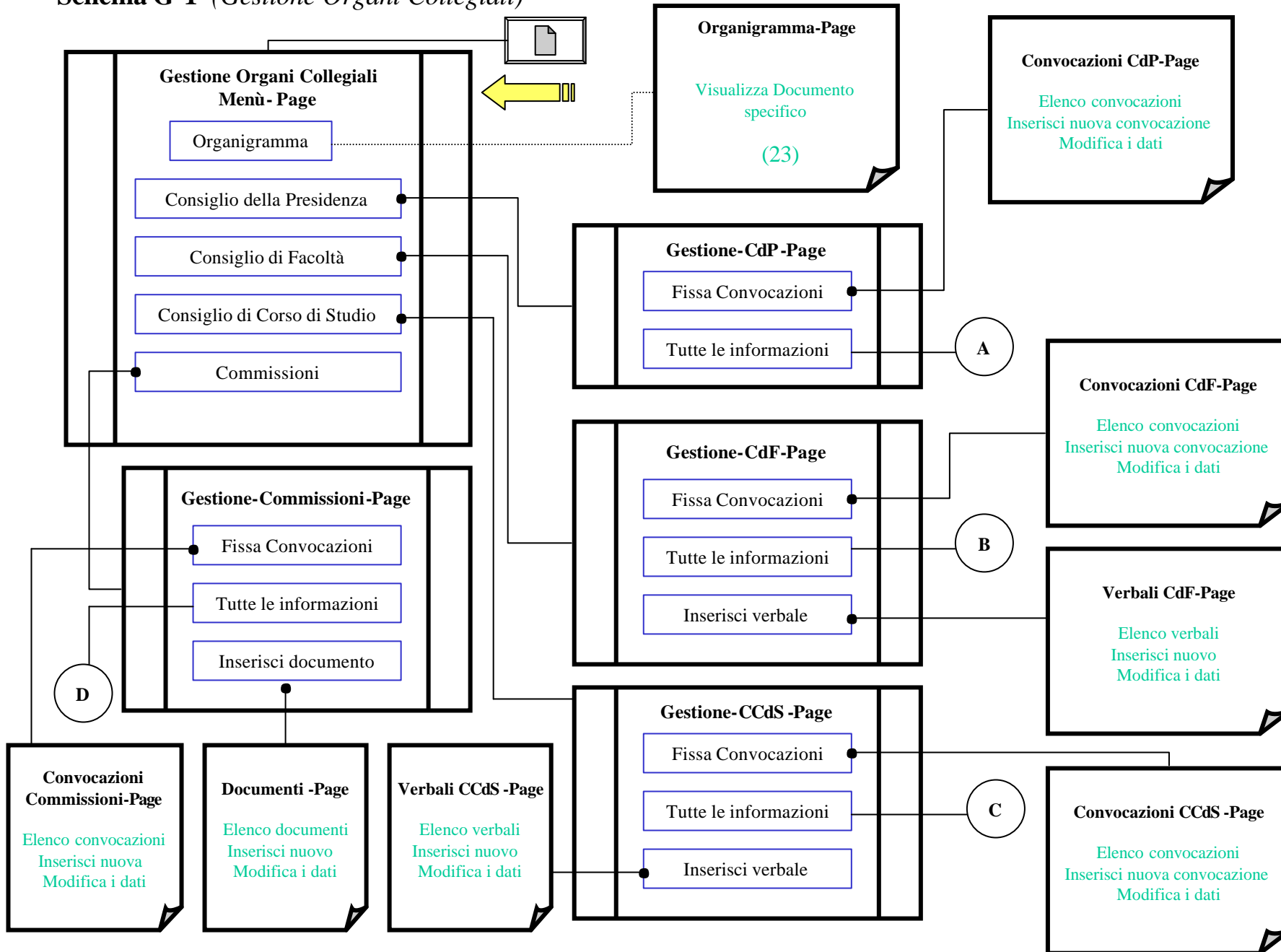

Schema V-1 (Vista Organi Collegiali)

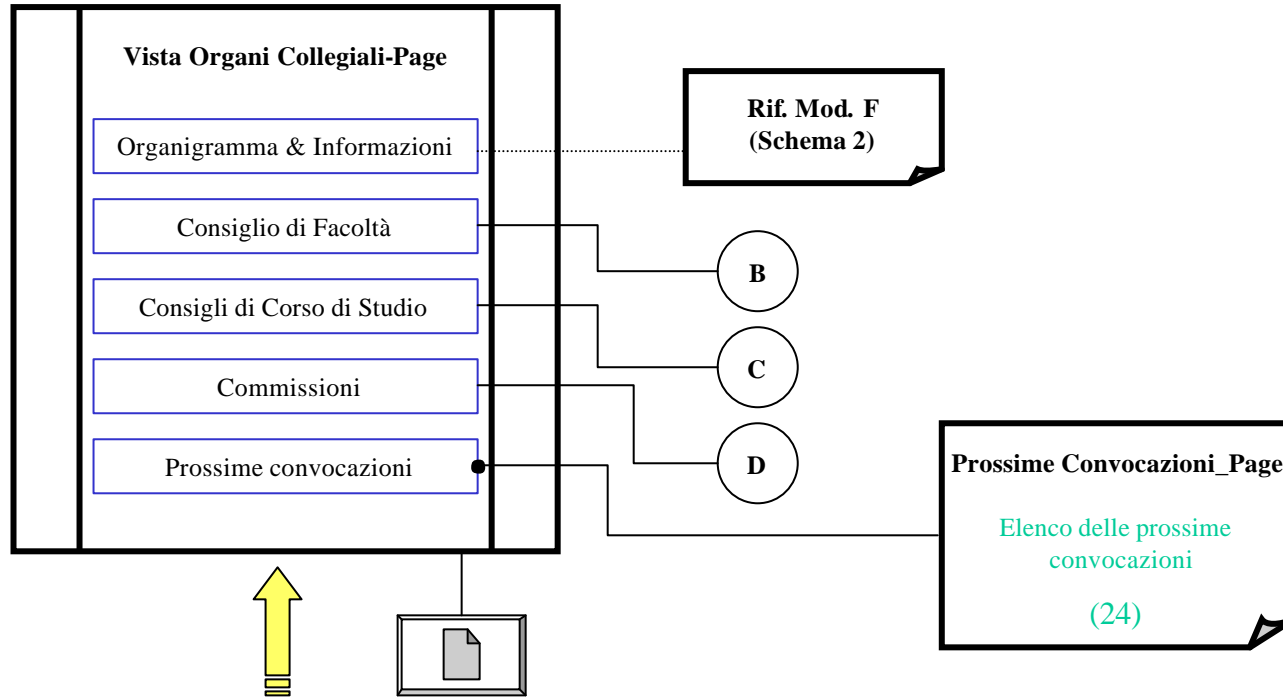

Schema V-2 (Vista Consiglio della Presidenza)

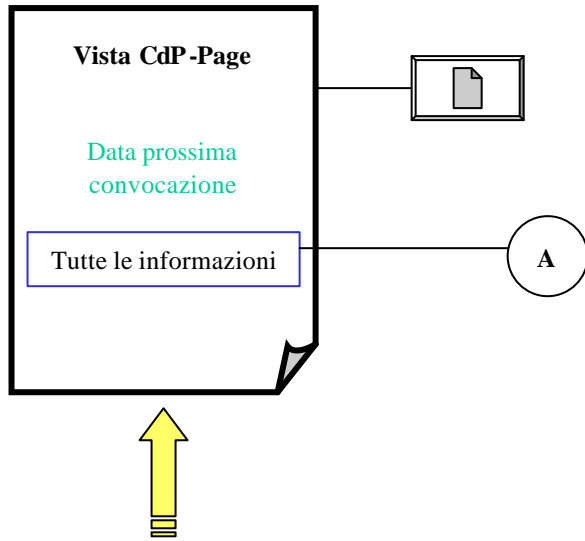

Schema G-2 (Gestione Date Appelli)

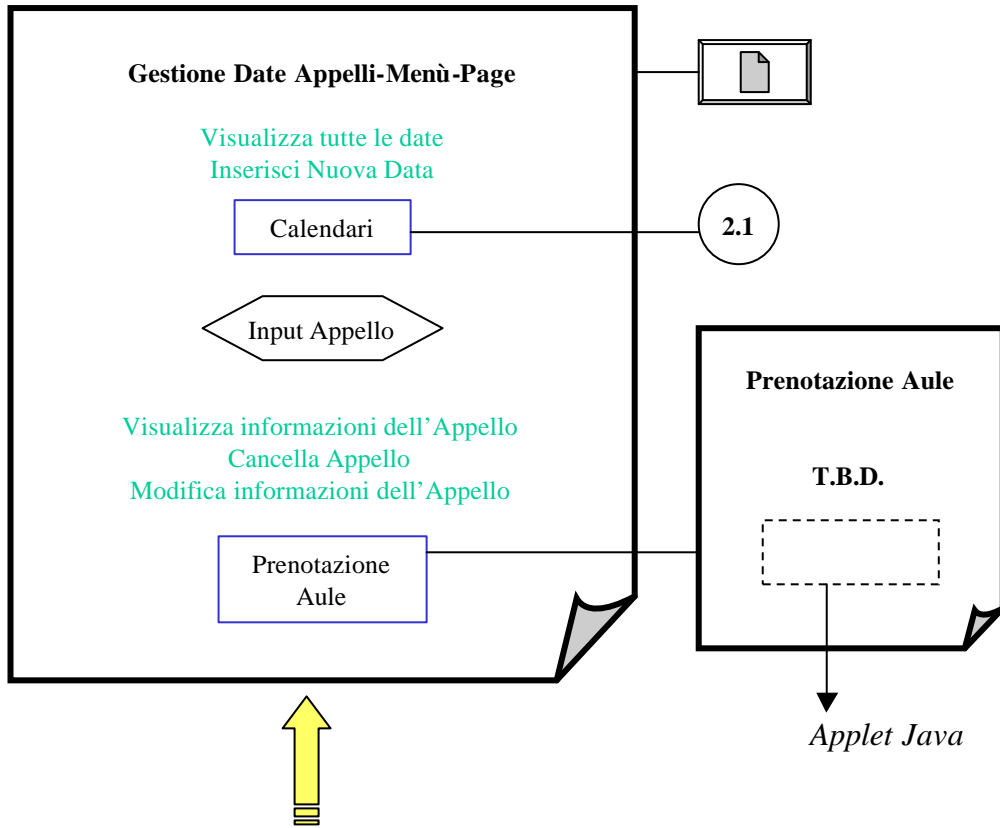

Schema G-3 (*Gestione Liste Appelli*)

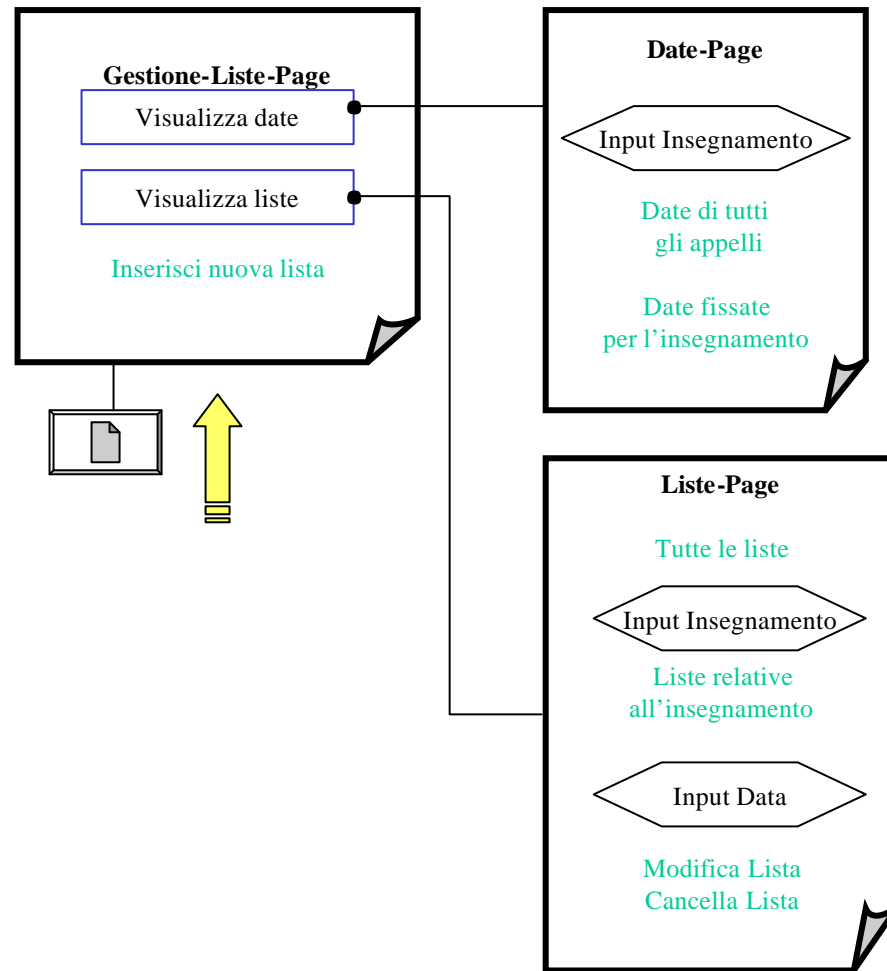

Schema G-4 (*Gestione Pubblicazione esiti delle prove scritte*)

T.B.D.

Schema V-3 (Vista Appelli)

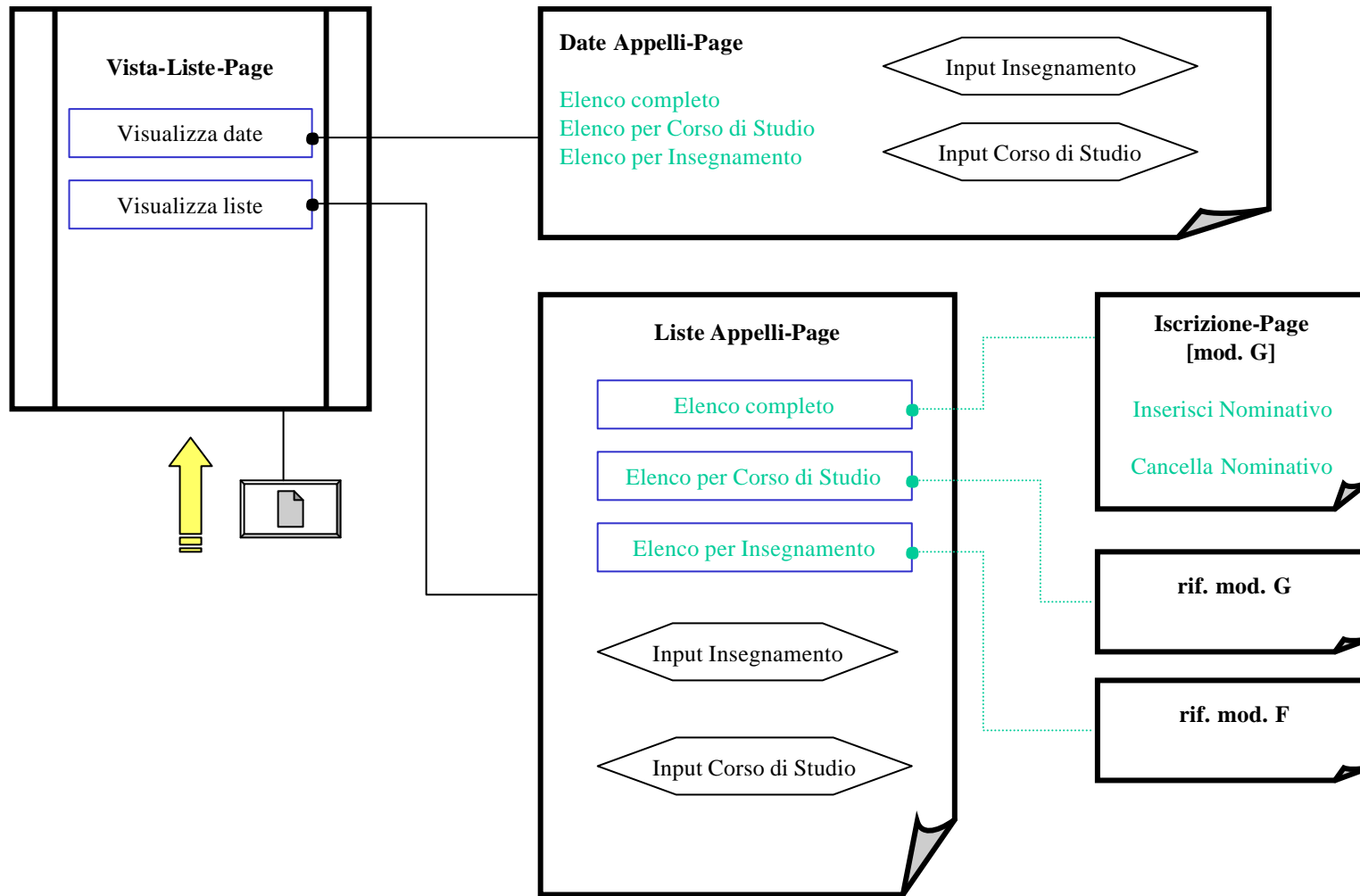

Schema E-V-3 (Vista Appelli-Inglese)

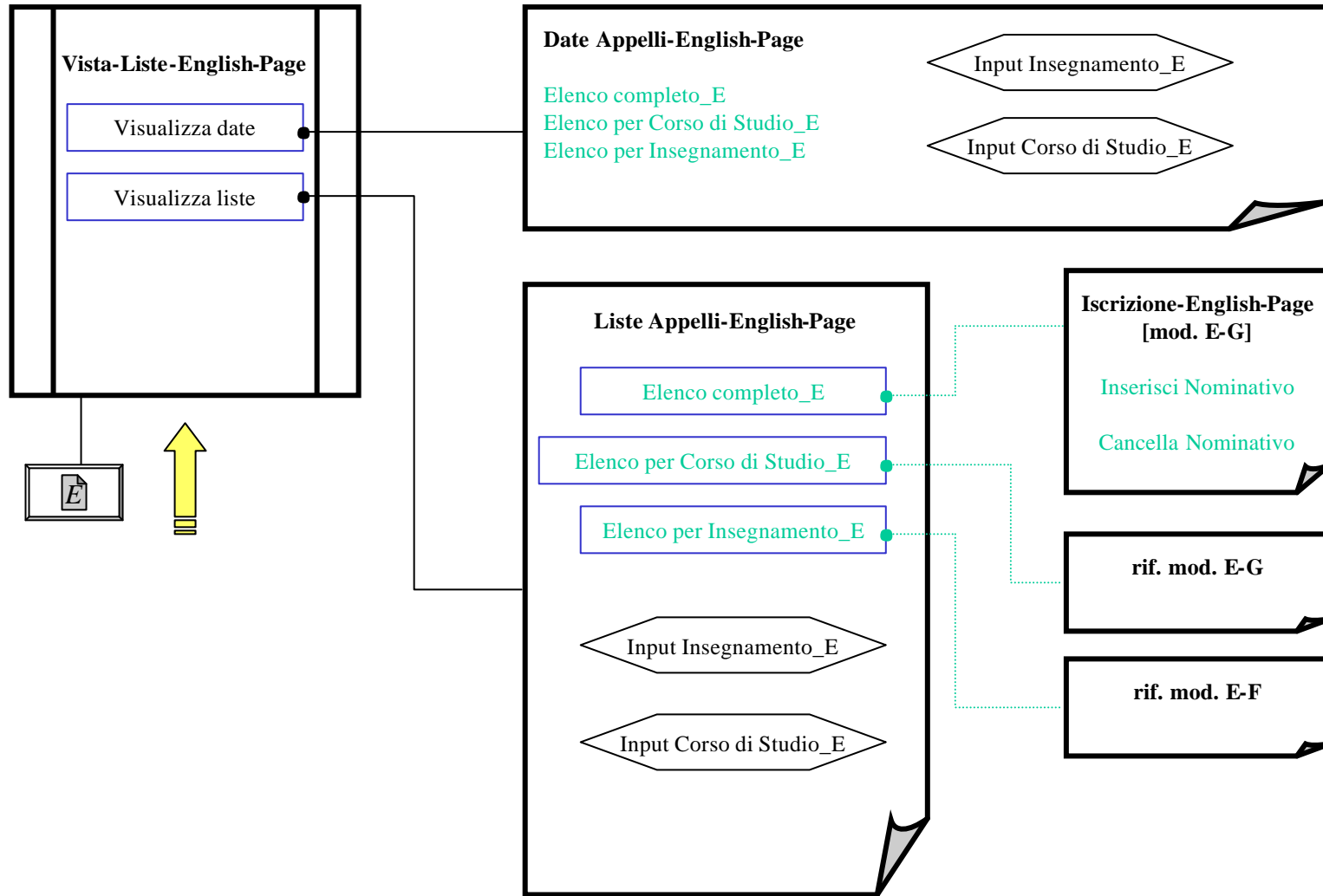

Schema G-5 (Gestione Orario delle lezioni)

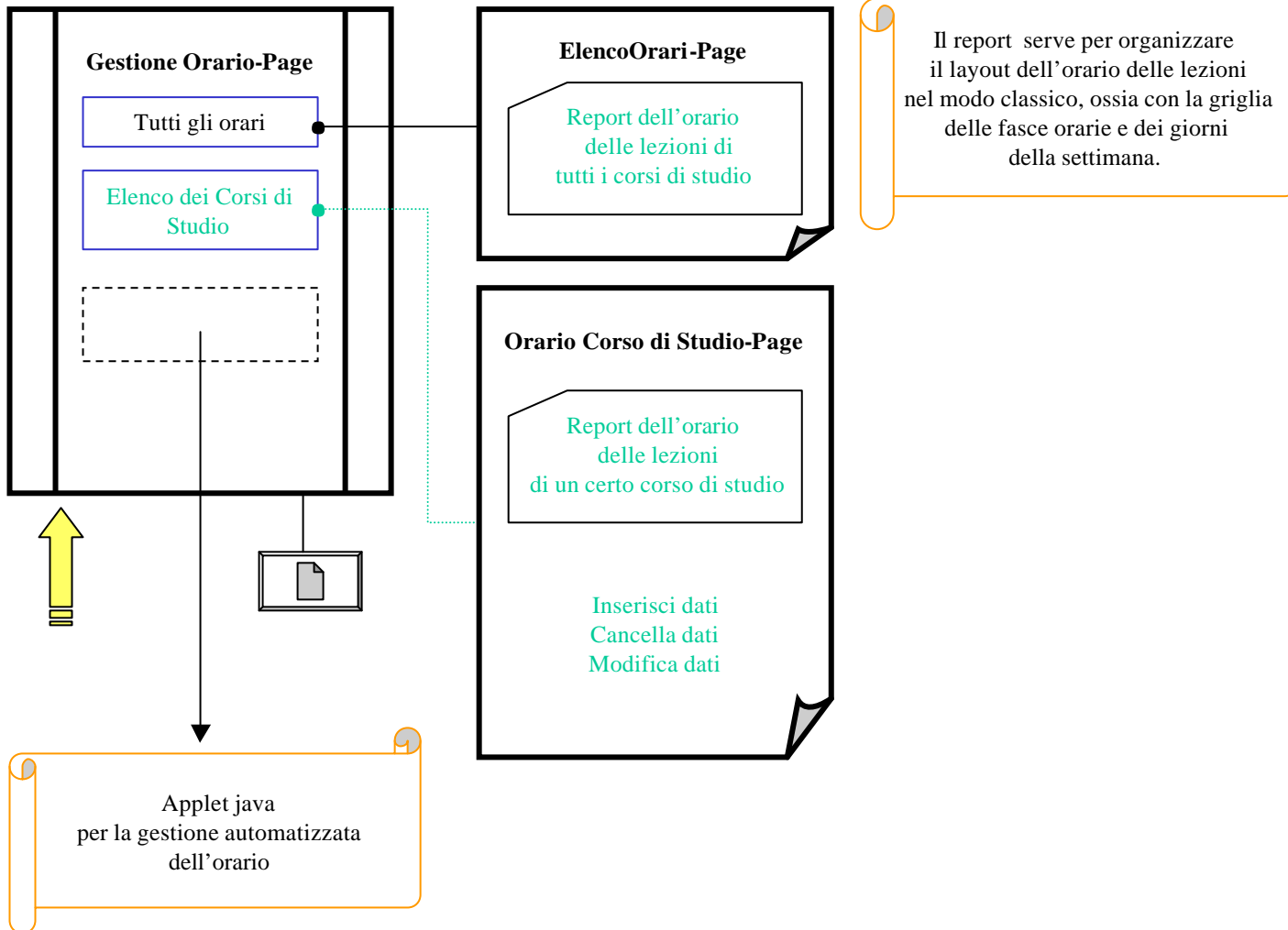

Schema G-6 (Gestione Moduli per le pratiche burocratiche degli Studenti)

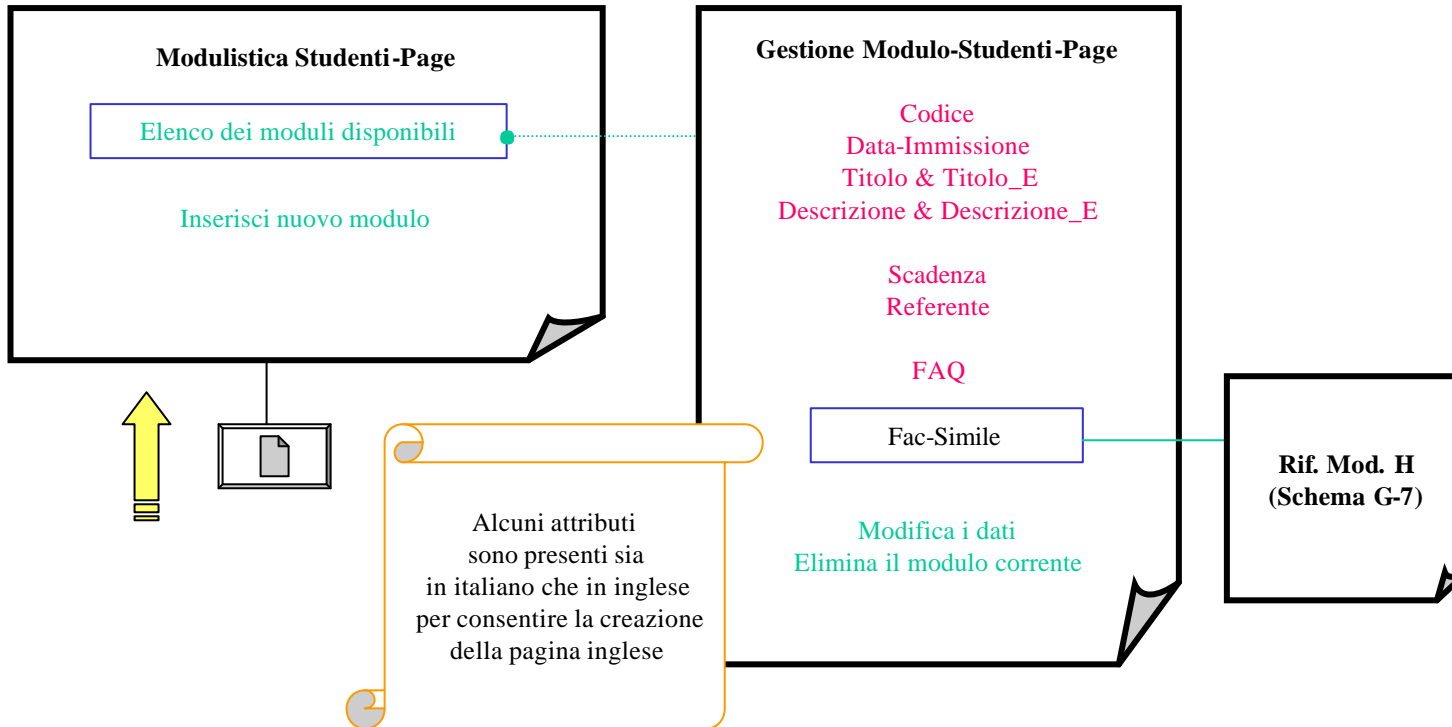

Schema G-7 (Gestione Moduli per le pratiche burocratiche del Personale)

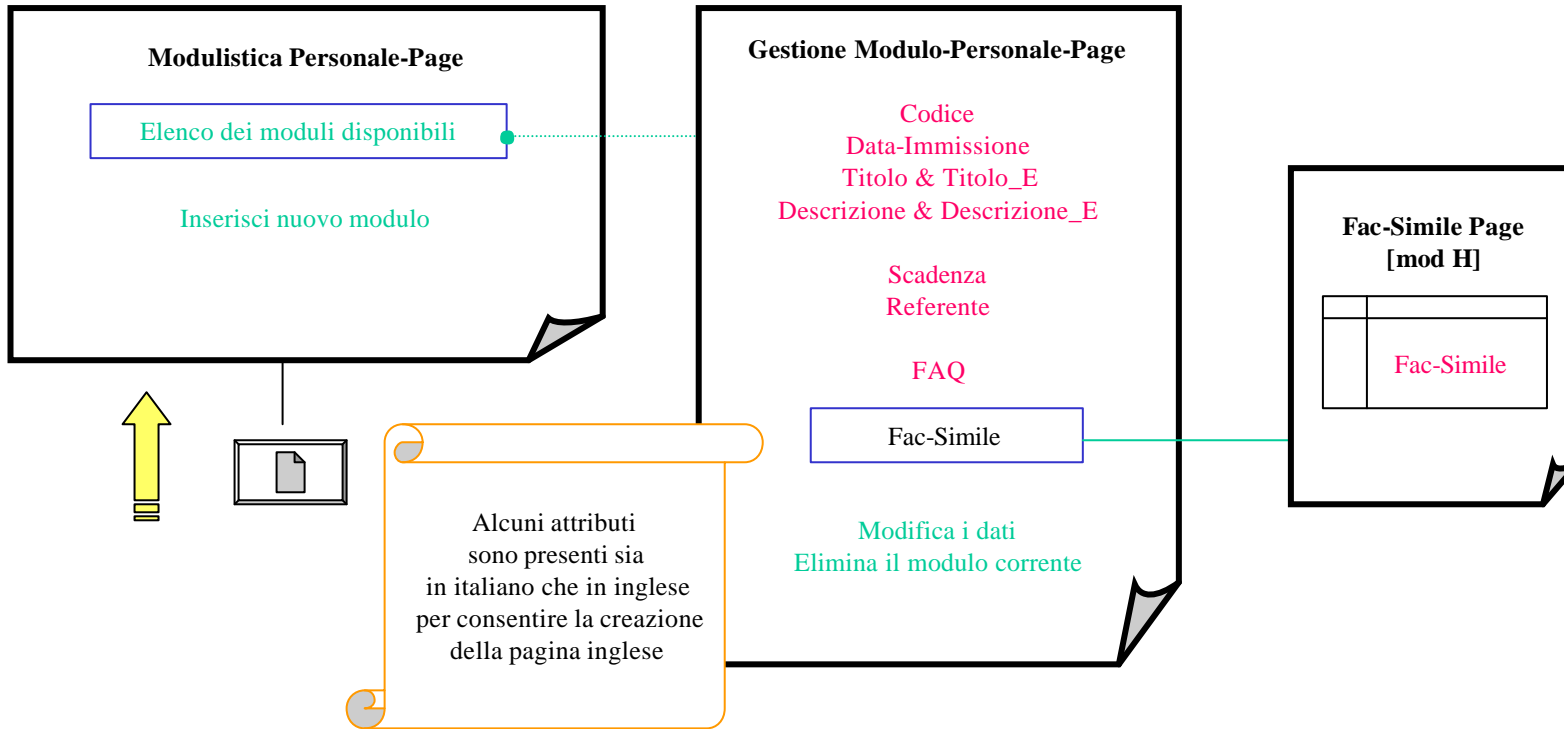

Schema V-4 (*Vista Moduli del Personale*)

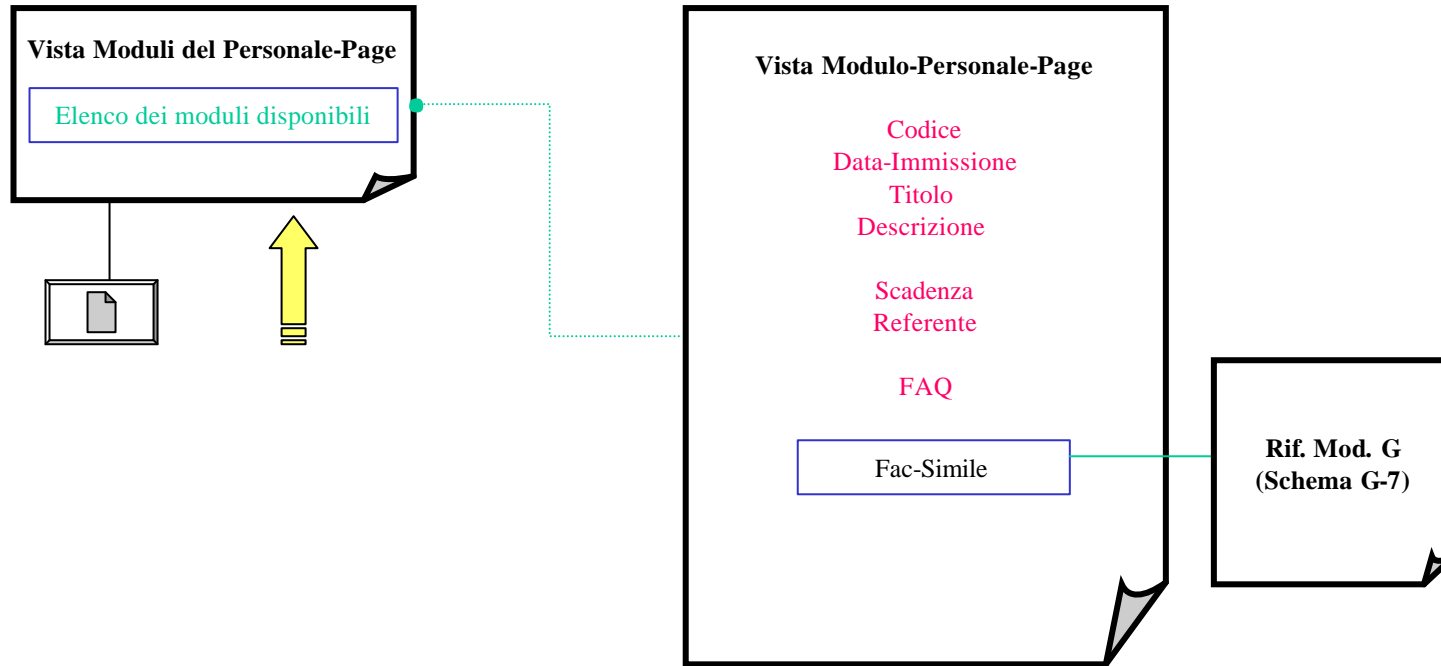

Schema E-V-4 (*Vista Moduli del Personale versione inglese*)

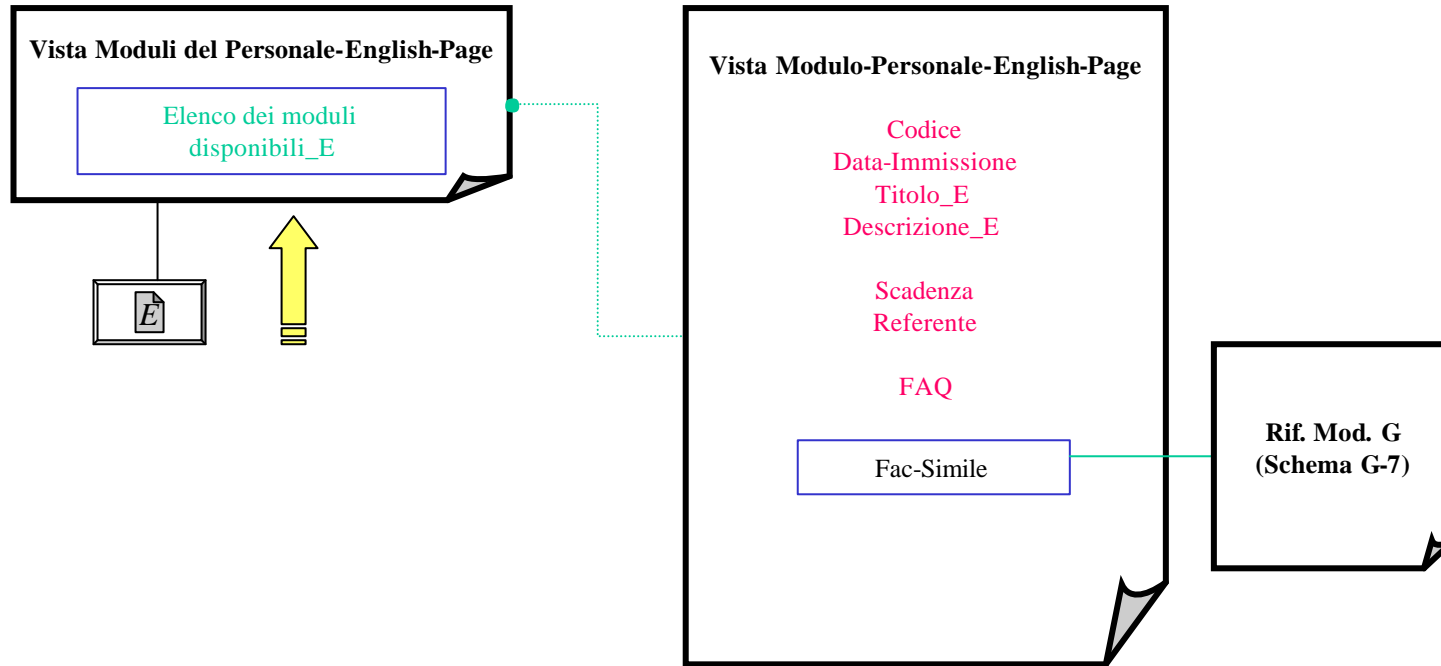

Schema G-8 (Gestione Avvisi relativi ad un Insegnamento)

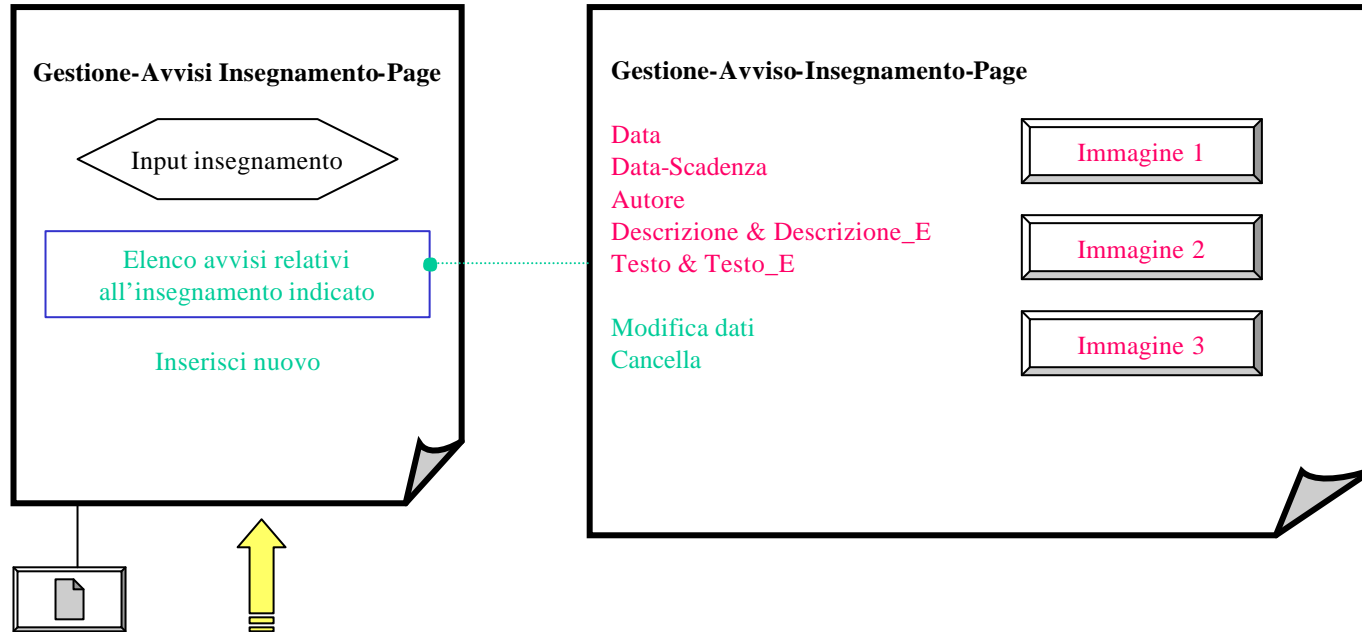

Schema G-9 (Gestione Avvisi dei Rappresentanti degli Studenti)

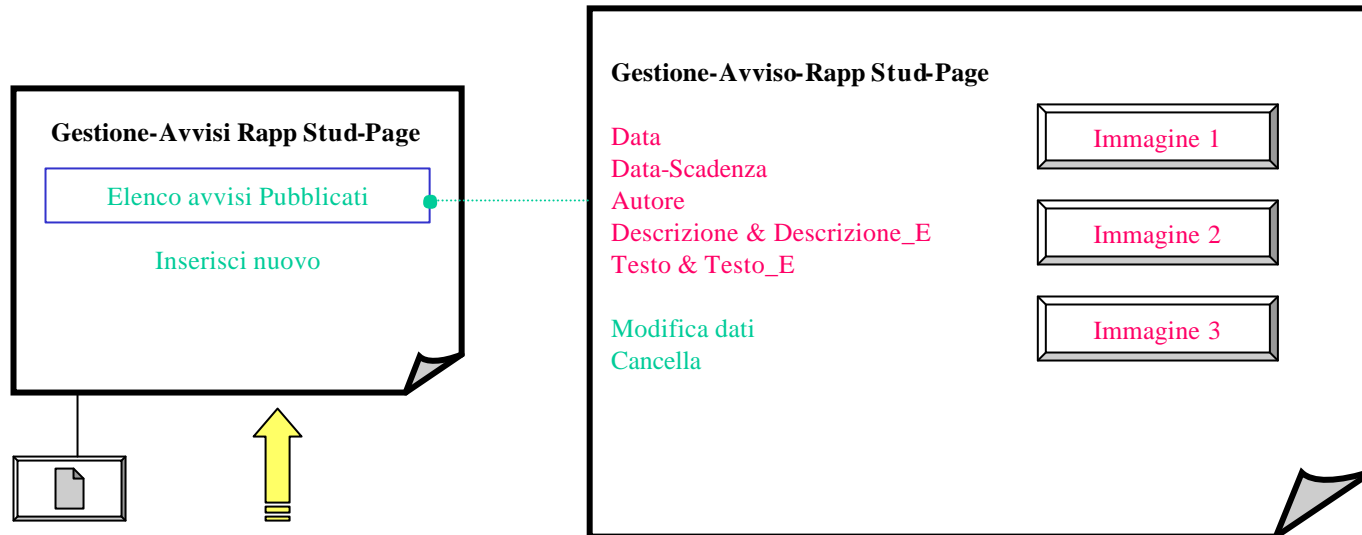

Schema G-10 (Gestione Avvisi relativi alla Facoltà)

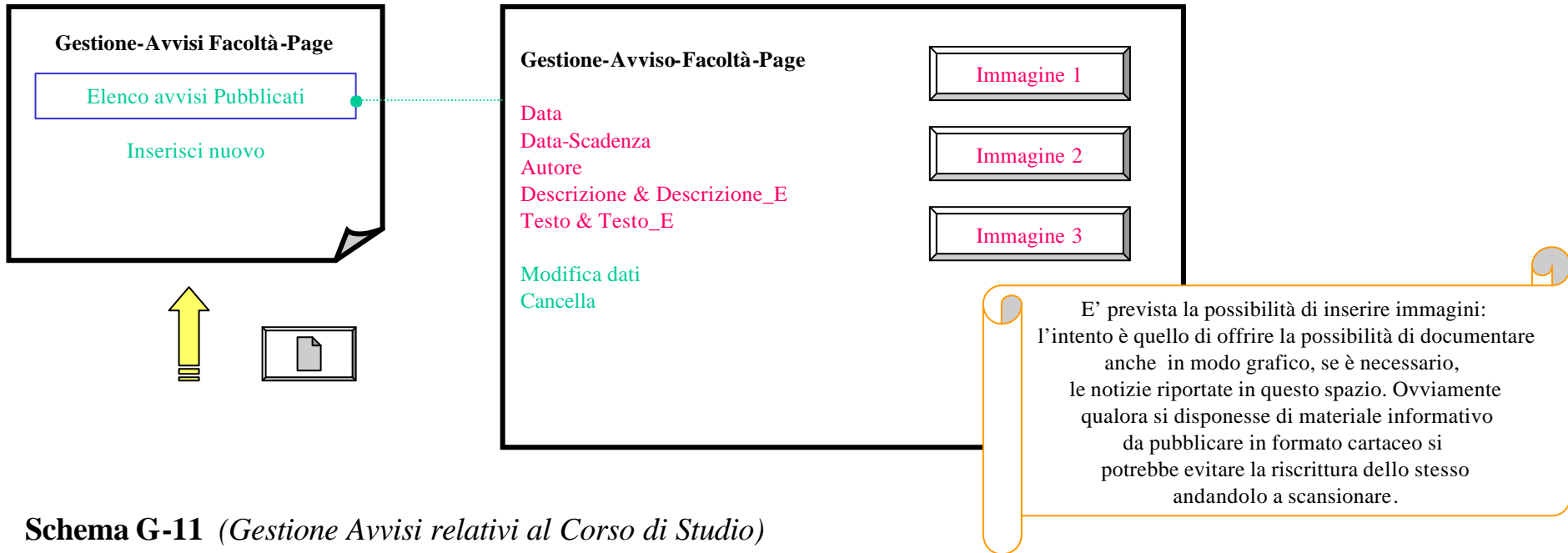

Schema G-11 (Gestione Avvisi relativi al Corso di Studio)

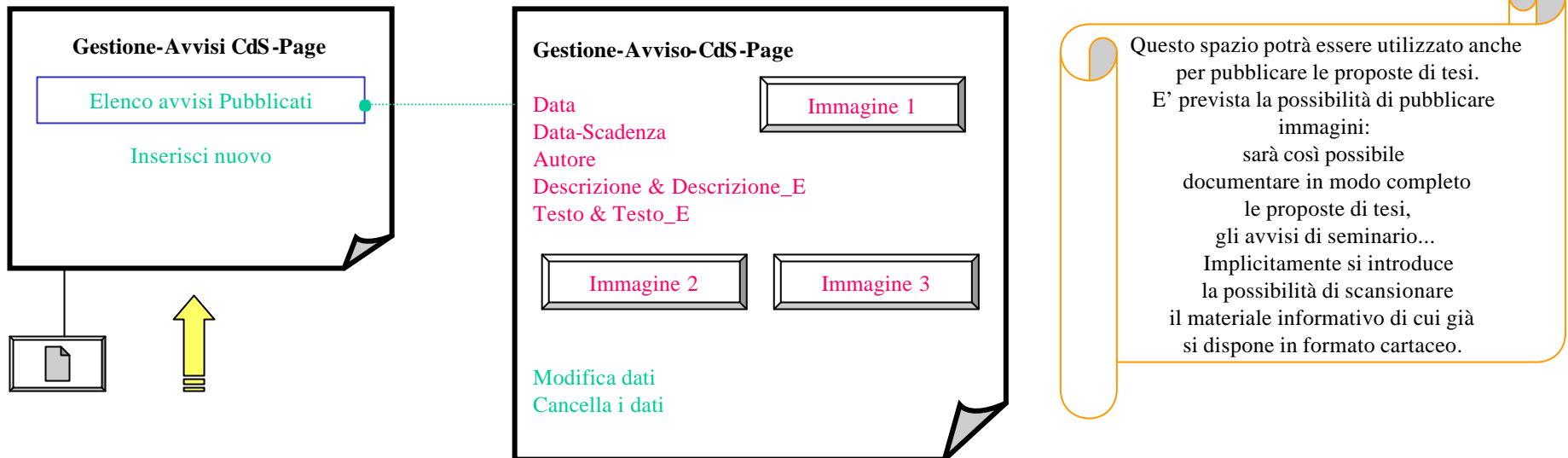

Schema G-12 (*Gestione dei documenti*)

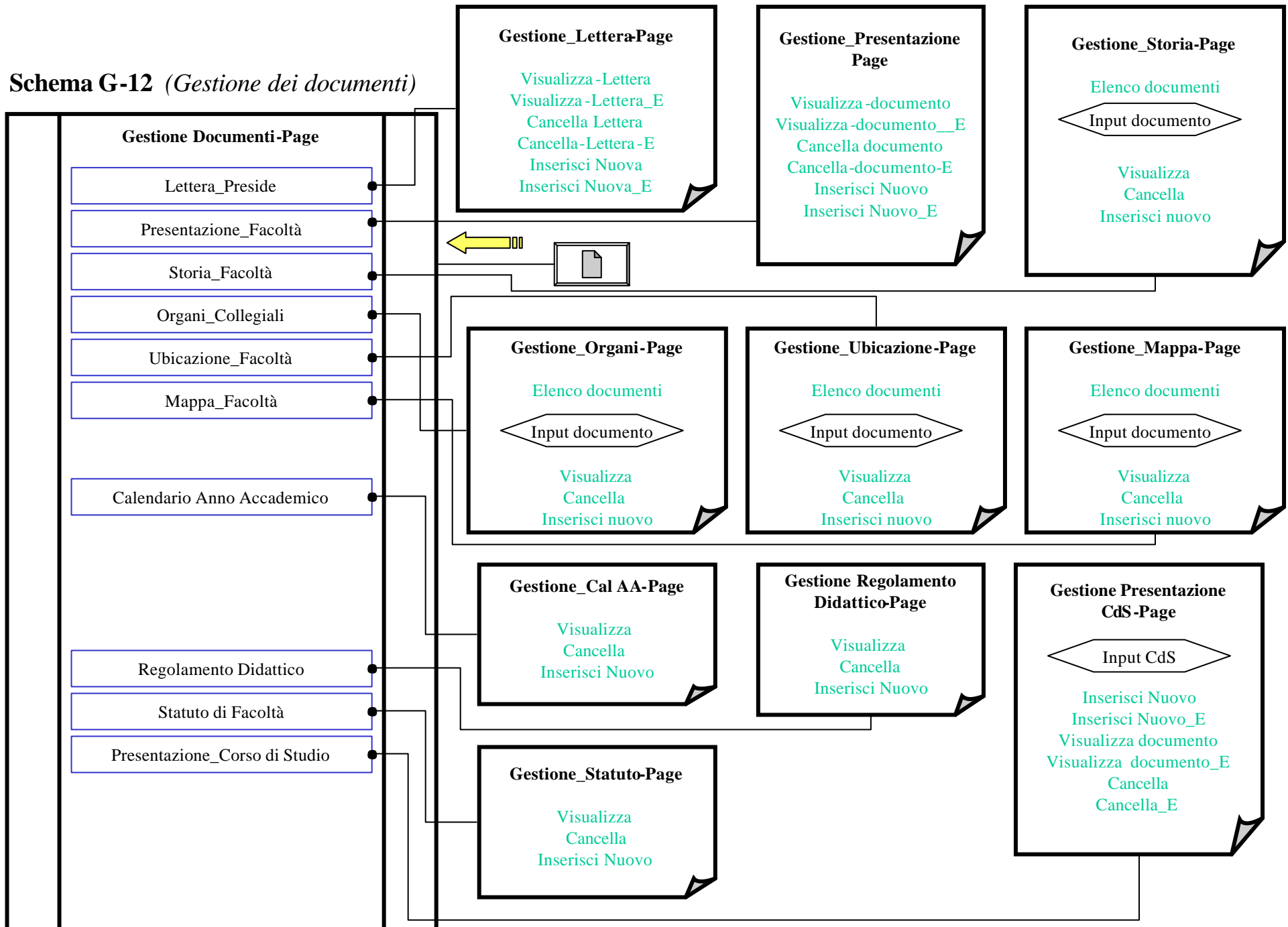

Schema G-13 (Gestione degli altri documenti)

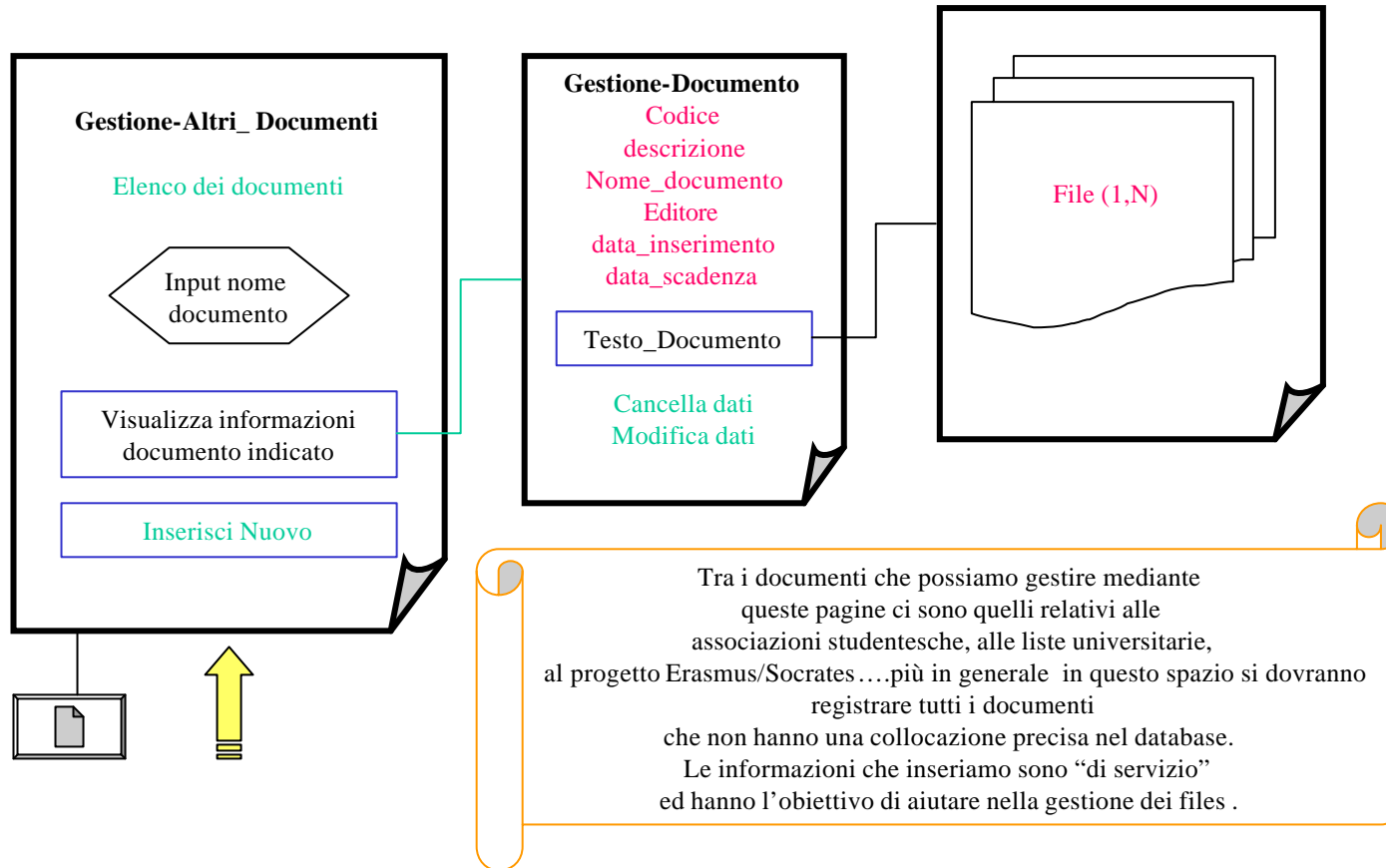

Tra i documenti che possiamo gestire mediante queste pagine ci sono quelli relativi alle associazioni studentesche, alle liste universitarie, al progetto Erasmus/Socrates...più in generale in questo spazio si dovranno registrare tutti i documenti che non hanno una collocazione precisa nel database. Le informazioni che inseriamo sono "di servizio" ed hanno l'obiettivo di aiutare nella gestione dei files .

Schema G-14 (*Gestione Insegnamenti*)



La descrizione ivi fornita della gestione degli insegnamenti è da ritenersi puramente indicativa
T.B.D.

Schema G-15 (Gestione Personale)

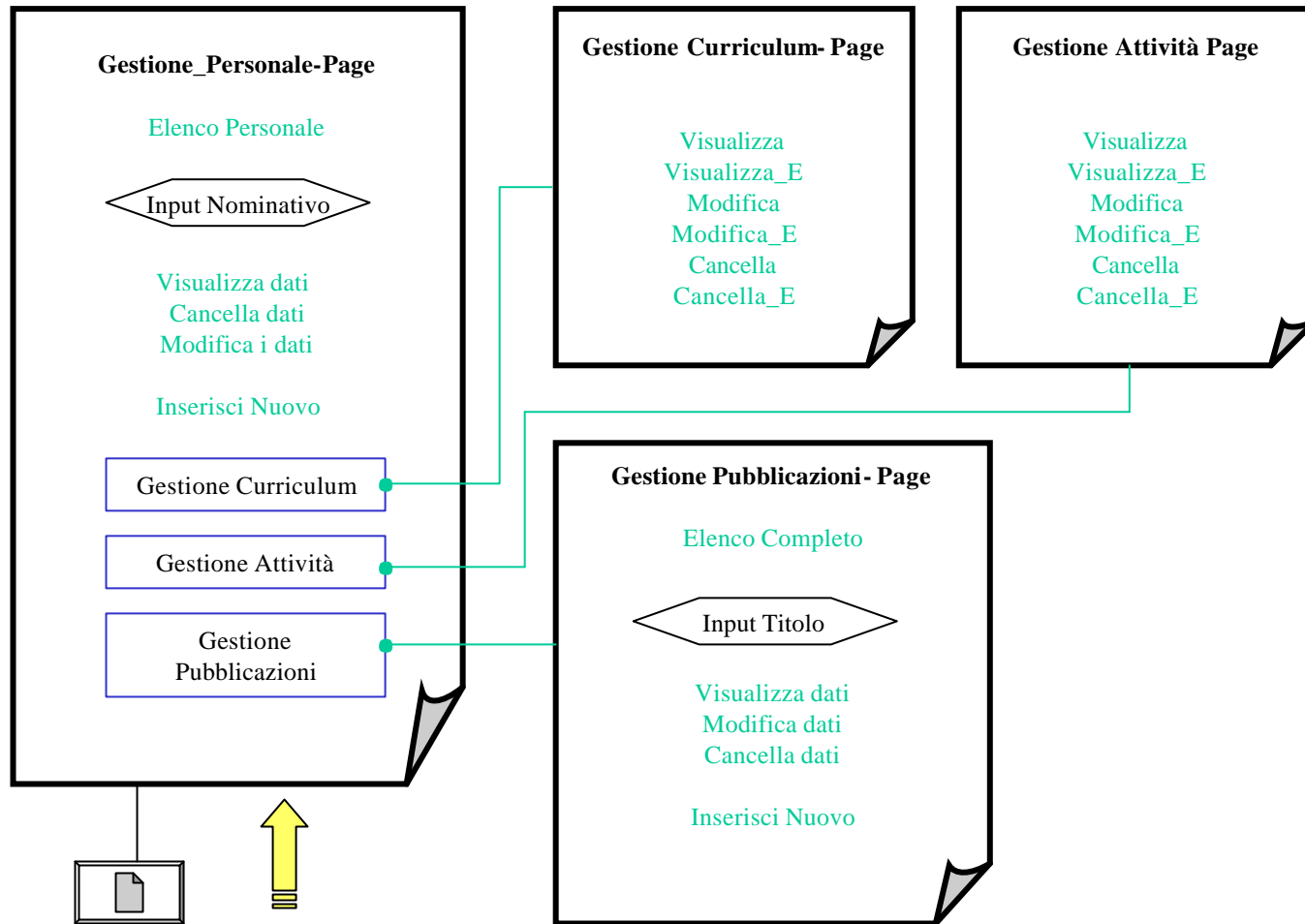

Schema G-16 (*Gestione Laboratori*)

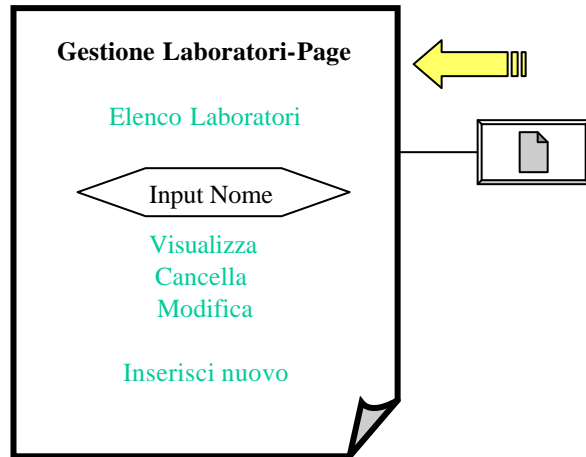

Schema G-17 (*Gestione Calendari Sessioni d'Esame*)

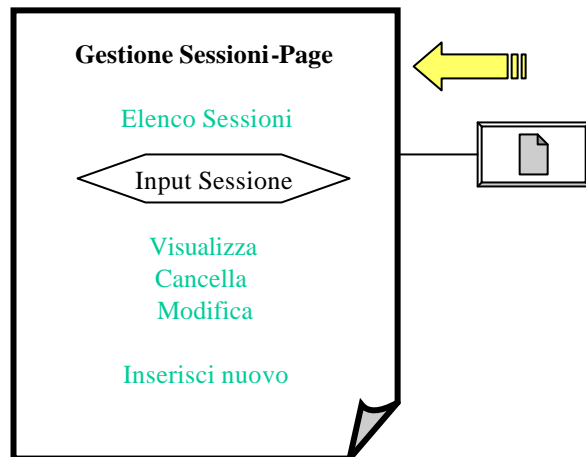

Schema G-18 (*Gestione Commissioni d'Esame*)

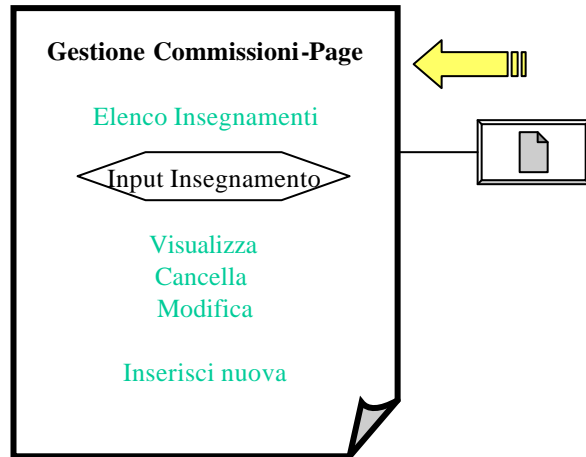

Schema G-19 (*Gestione Calendario Lauree*)

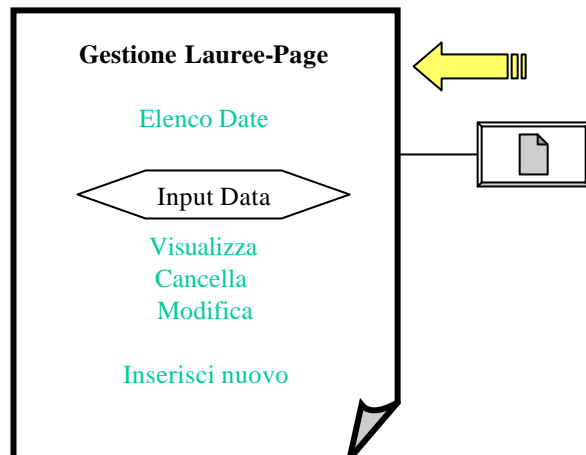

Schema G-20 (*Gestione Esami di Stato*)

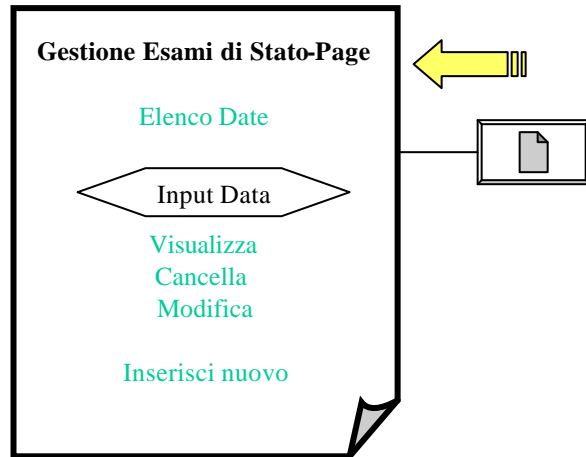

Schema V-5 (*"Scadenziario" Docenti*)

